

PRODUCT CATALOG
Landscape Lighting 2019-2020



FNM GENERAL TRADING LLC

info@fnmgtllc.com

www.fnmgtllc.com

Tel: +971 52 195 4650, +971 54 364 9630

Media City Sharjah, United Arab Emirates

Advanced Technologies in Lighting Solutions



OUTDOOR
LIGHTING SOLUTION



General Trading LLC

CONTENTS

- LED Path Lights*
- LED Uper Lights*
- LED Wall Washer Lights*
- LED Underground Lights*
- LED Flood Lights*
- LED Sport Lights*
- LED Corrugated Lights*



Product Overview

LED Path Light

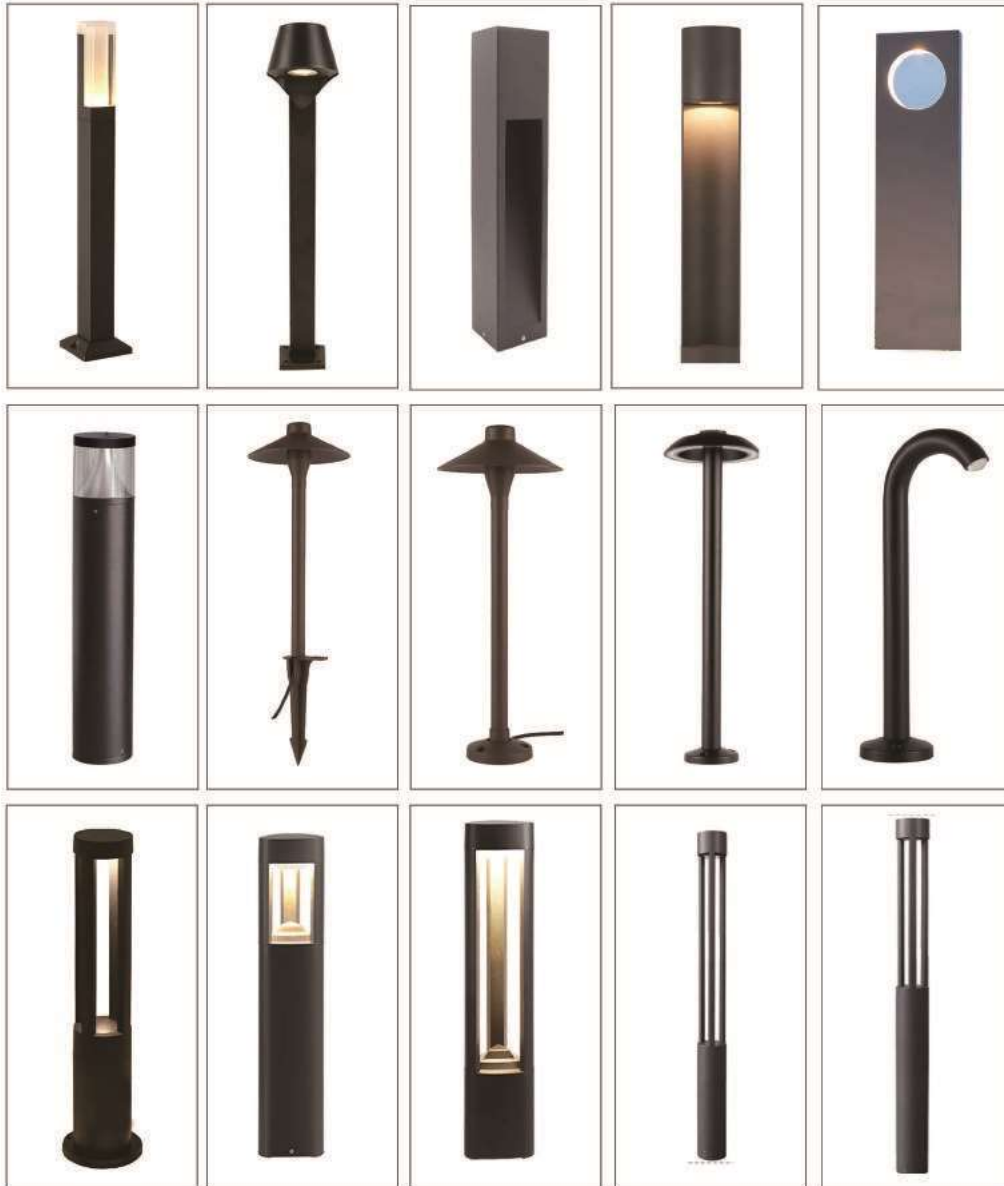

LED Uper Light



LED Wall Washer Light



LED Underground Light



LED Spot Light



LED Flood Light



LED Corrugated Light





LED Flood Light

Decoration Building
Decoration house
Residential Area
Village Road

LED Street Light

High Way
Urban Road
Parking lot
Industry Side



LED High Bay

Warehouse
Interior Gym
Supermarket
Factory

LED Landscape Light

Public Park
House courtyard



LED Stadium Light

Car parking area
High mast installation dock
Railway
Container yard
Sea ports
Sport hall



LED Tunnel Light

Highway Tunnel
Industry sites
Square area
Parking lot

Product Portfolio





LED Down Light



Model No: MD-C1930	Surface Treatment: WHSN
Power: COB 30W	Life Span: 30000H
Input Voltage: AC220-240V/50/60Hz	Material: Alum+Glass+PC
Luminous Flux: 2400Lm	Working Temperature: -10~45° C
CFR: ≥80	IP: 20
Beam Angle: 145°	Body Size: Φ225*80mm
Color Temperature: 6500/4000/3000K	Hole Size: Φ200mm



MD-C1930

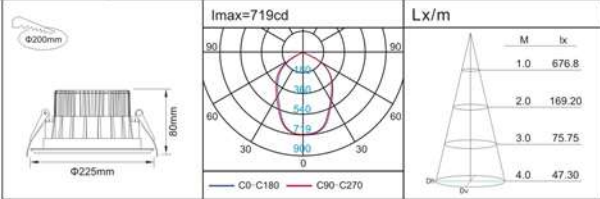

Products list

Model No.	Power	Luminous Flux	Beam angle	Surface	Body Size	Hole Size
MD-C1910	COB 10W	800Lm	120°	WHSN	Φ135x70mm	Φ110mm
MD-C1915	COB 15W	1200Lm	145°	WHSN	Φ175x75mm	Φ155mm
MD-C1920	COB 20W	1600Lm	145°	WHSN	Φ195x80mm	Φ175mm
MD-C1930	COB 30W	2400Lm	145°	WHSN	Φ225x80mm	Φ200mm

Model No: MD-DLM3430R	Surface Treatment: WH
Power: COB 30W	Life Span: 25000H
Input Voltage: AC220-240V/50/60Hz	Material: Alum+Glass
Luminous Flux: 2400Lm	Working Temperature: -10~45° C
CFR: ≥70	IP: 20
Beam Angle: 100°	Body Size: Φ220*41mm
Color Temperature: 6500/4000/3000K	Hole Size: /



MD-DLM3430R

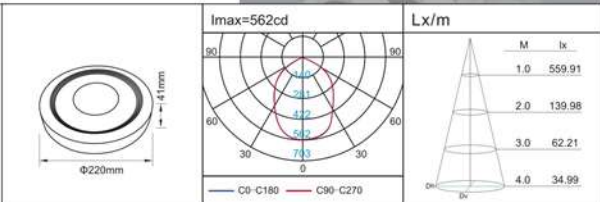

Products list

Model No.	Power	Luminous Flux	Beam angle	Surface	Body Size	Hole Size
MD-DLM3430R	COB 30W	2400Lm	100°	WH	Φ220x41mm	/
MD-DLM3440R	COB 40W	3200Lm	100°	WH	Φ300x50mm	/



LED Down Light



Model No: MD-DLQ7005R	Surface Treatment: WH
Power: SMD 5W	Life Span: 25000H
Input Voltage: AC220-240V/50/60Hz	Material: Alum+PC
Luminous Flux: 400Lm	Working Temperature: -10~45° C
CFR: ≥80	IP: 20
Beam Angle: 120°	Body Size: Φ100*35mm
Color Temperature: 6500/4000/3000K	Hole Size: Φ75mm



MD-DLQ7005R

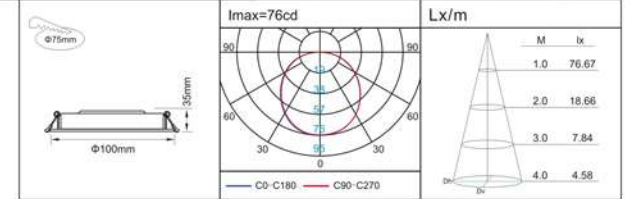

Products list

Model No.	Power	Luminous Flux	Beam angle	Surface	Body Size	Hole Size
MD-DLQ7005R	SMD 5W	400Lm	120°	WH	Φ100x35mm	Φ75mm
MD-DLQ7007R	SMD 7W	510Lm	120°	WH	Φ115x35mm	Φ85mm
MD-DLQ7012R	SMD 12W	1000Lm	120°	WH	Φ152x35mm	Φ120mm
MD-DLQ7018R	SMD 18W	1450Lm	120°	WH	Φ185x35mm	Φ155mm
MD-DLQ7025R	SMD 25W	2300Lm	120°	WH	Φ225x58mm	Φ195mm





Down Light



Model No: V-DLQ2260R	Surface Treatment: WH
Power: COB 60W	Life Span: 30000H
Input Voltage: AC220-240V/50/60Hz	Material: Alum+Glass+PC
Luminous Flux: 5700Lm	Working Temperature: -10~45° C
CR: >85	IP: 20
Beam Angle: 70°	Body Size: Φ230*110mm
Color Temperature: 6500/4000/3000K	Hole Size: Φ215mm



V-DLQ2260R

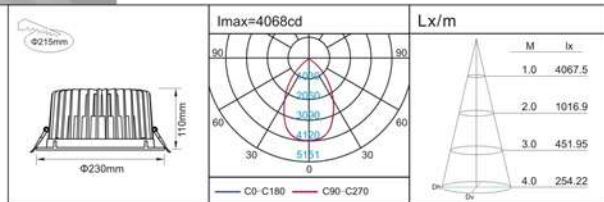

Products list

Model No.	Power	Luminous Flux	Beam angle	Surface	Body Size	Hole Size
V-DLQ2260R	COB 60W	5700Lm	70°	WH	Φ230x110mm	Φ215mm
V-DLQ2260S	COB 60W	5700Lm	70°	WH	230x230x110mm	Φ215mm

Model No: V-DLQ2280R	Surface Treatment: WH
Power: COB 60W	Life Span: 30000H
Input Voltage: AC220-240V/50/60Hz	Material: Alum+Glass+PC
Luminous Flux: 7000Lm	Working Temperature: -10~45° C
CR: >85	IP: 20
Beam Angle: 60°	Body Size: Φ225*120mm
Color Temperature: 6500/4000/3000K	Hole Size: Φ200mm



V-DLQ2280R

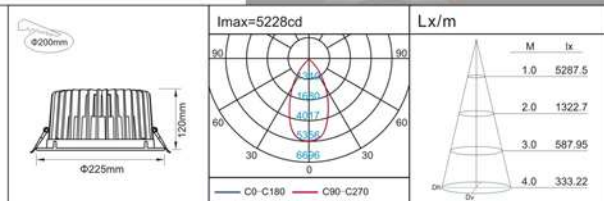

Down Light



Model No: MD-DLQ2250R	Surface Treatment: WH
Power: COB 50W	Life Span: 25000H
Input Voltage: AC220-240V/50/60Hz	Material: Alum+PC
Luminous Flux: 4800Lm	Working Temperature: -10~45° C
CR: >85	IP: 20
Beam Angle: 38°	Body Size: Φ230*103mm
Color Temperature: 6500/4000/3000K	Hole Size: Φ215mm



MD-DLQ2250R

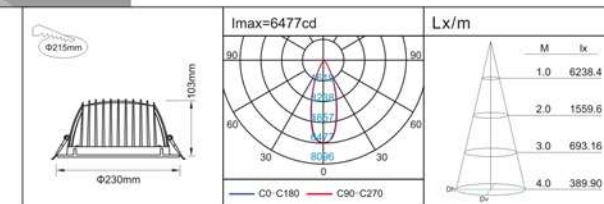

Products list

Model No.	Power	Luminous Flux	Beam angle	Surface	Body Size	Hole Size
MD-DLQ2250R	COB 50W	4800Lm	38°	WH	Φ230x103mm	Φ215mm
MD-DLQ2250S	COB 50W	4800Lm	38°	WH	230x230x103mm	Φ215mm



Model No: MD-DLQ3860R	Surface Treatment: WH
Power: COB 60W	Life Span: 25000H
Input Voltage: AC220-240V/50/60Hz	Material: Alum+Glass
Luminous Flux: 4800Lm	Working Temperature: -10~45° C
CR: >85	IP: 20
Beam Angle: 38°	Body Size: Φ230*117mm
Color Temperature: 6500/4000/3000K	Hole Size: Φ205mm



MD-DLQ3860R

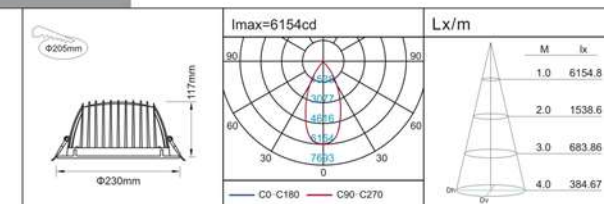

Products list

Model No.	Power	Luminous Flux	Beam angle	Surface	Body Size	Hole Size
MD-DLQ3812R	COB 12W	960Lm	38°	WH	Φ120x65mm	Φ105mm
MD-DLQ3830R	COB 30W	2400Lm	38°	WH	Φ175x80mm	Φ150mm
MD-DLQ3860R	COB 60W	4800Lm	38°	WH	Φ230x117mm	Φ205mm



LED Down Light



Model No: MD-C1930	Surface Treatment: WHSN
Power: COB 30W	Life Span: 30000H
Input Voltage: AC220-240V/50/60Hz	Material: Alum+Glass+PC
Luminous Flux: 2400Lm	Working Temperature: -10~45° C
CFR: ≥80	IP: 20
Beam Angle: 145°	Body Size: Φ225*80mm
Color Temperature: 6500/4000/3000K	Hole Size: Φ200mm



MD-C1930

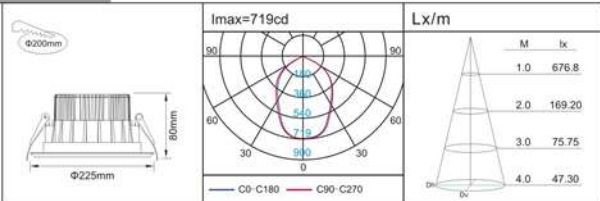

Products list

Model No.	Power	Luminous Flux	Beam angle	Surface	Body Size	Hole Size
MD-C1910	COB 10W	800Lm	120°	WHSN	Φ135x70mm	Φ110mm
MD-C1915	COB 15W	1200Lm	145°	WHSN	Φ175x75mm	Φ155mm
MD-C1920	COB 20W	1600Lm	145°	WHSN	Φ195x80mm	Φ175mm
MD-C1930	COB 30W	2400Lm	145°	WHSN	Φ225x80mm	Φ200mm

Model No: MD-DLM3430R	Surface Treatment: WH
Power: COB 30W	Life Span: 25000H
Input Voltage: AC220-240V/50/60Hz	Material: Alum+Glass
Luminous Flux: 2400Lm	Working Temperature: -10~45° C
CFR: ≥70	IP: 20
Beam Angle: 100°	Body Size: Φ220*41mm
Color Temperature: 6500/4000/3000K	Hole Size: /



MD-DLM3430R

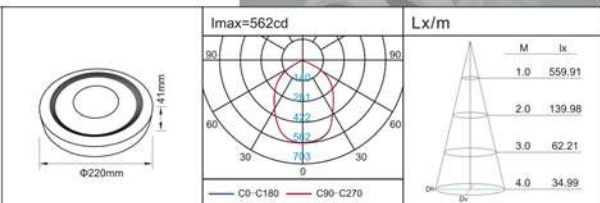

Products list

Model No.	Power	Luminous Flux	Beam angle	Surface	Body Size	Hole Size
MD-DLM3430R	COB 30W	2400Lm	100°	WH	Φ220x41mm	/
MD-DLM3440R	COB 40W	3200Lm	100°	WH	Φ300x50mm	/



LED Down Light



Model No: MD-DLQ7005R	Surface Treatment: WH
Power: SMD 5W	Life Span: 25000H
Input Voltage: AC220-240V/50/60Hz	Material: Alum+PC
Luminous Flux: 400Lm	Working Temperature: -10~45° C
CFR: ≥80	IP: 20
Beam Angle: 120°	Body Size: Φ100*35mm
Color Temperature: 6500/4000/3000K	Hole Size: Φ75mm



MD-DLQ7005R

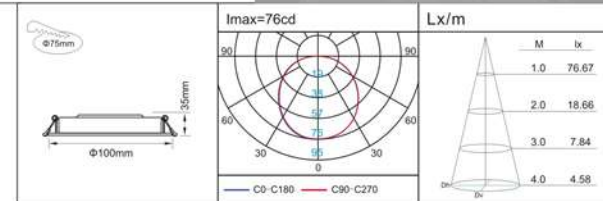

Products list

Model No.	Power	Luminous Flux	Beam angle	Surface	Body Size	Hole Size
MD-DLQ7005R	SMD 5W	400Lm	120°	WH	Φ100x35mm	Φ75mm
MD-DLQ7007R	SMD 7W	510Lm	120°	WH	Φ115x35mm	Φ85mm
MD-DLQ7012R	SMD 12W	1000Lm	120°	WH	Φ152x35mm	Φ120mm
MD-DLQ7018R	SMD 18W	1450Lm	120°	WH	Φ185x35mm	Φ155mm
MD-DLQ7025R	SMD 25W	2300Lm	120°	WH	Φ225x58mm	Φ195mm





LED Down Light



Model No: MD-DL-Q2010R	Surface Treatment: WH/SN
Power: COB 10W	Life Span: 25000H
Input Voltage: AC220-240V 50/60Hz	Material: Alum+Glass+PC
Luminous Flux: 800Lm	Working Temperature: -10~45° C
CR: >70	IP: 20
Beam Angle: 120°	Body Size: Φ124*36mm
Color Temperature: 6500/4000/3000K	Hole Size: Φ110mm



MD-DL-Q2010R

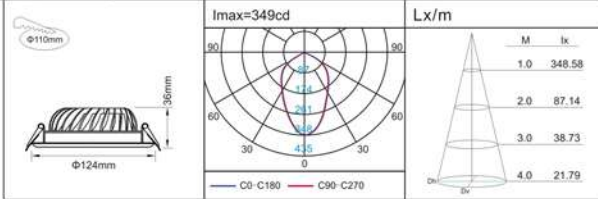

Products list

Model No.	Power	Luminous Flux	Beam angle	Surface	Body Size	Hole Size
MD-DL-Q2010R	COB 10W	800Lm	120°	WH/SN	Φ124x36mm	Φ110mm
MD-DL-Q2015R	COB 15W	1200Lm	120°	WH/SN	Φ165x41mm	Φ140mm
MD-DL-Q2020R	COB 20W	1600Lm	120°	WH/SN	Φ187x48mm	Φ170mm
MD-DL-Q2030R	COB 30W	2400Lm	120°	WH/SN	Φ227x61mm	Φ205mm

Model No: MD-DL-Q6206R	Surface Treatment: WH
Power: SMD 6W	Life Span: 25000H
Input Voltage: AC220-240V 50/60Hz	Material: Alum+PC
Luminous Flux: 420Lm	Working Temperature: -10~45° C
CR: >70	IP: 50
Beam Angle: 120°	Body Size: Φ98*42mm
Color Temperature: 6500/4000/3000K	Hole Size: Φ80mm



MD-DL-Q6206R

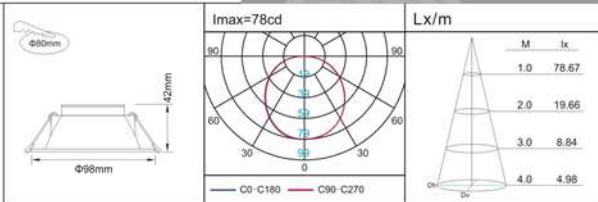

Products list

Model No.	Power	Luminous Flux	Beam angle	Surface	Body Size	Hole Size
MD-DL-Q6206R	SMD 6W	420Lm	120°	WH	Φ98x42mm	Φ80mm
MD-DL-Q6209R	SMD 9W	630Lm	120°	WH	Φ121x49mm	Φ95mm
MD-DL-Q6212R	SMD 12W	840Lm	120°	WH	Φ147x55mm	Φ120mm
MD-DL-Q6218R	SMD 18W	1260Lm	120°	WH	Φ177x58mm	Φ150mm
MD-DL-Q6224R	SMD 24W	1680Lm	120°	WH	Φ213x68mm	Φ190mm

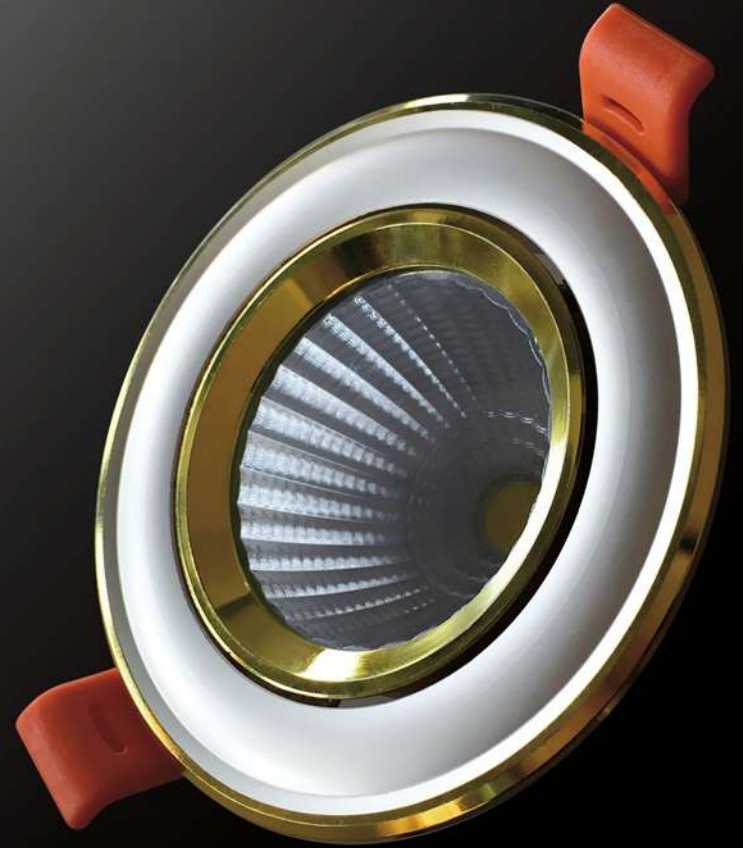

LED Spot Light



this kind of products are widely applied to hotel, store, home, museum and some other indoor places as the important spot lighting scenarios.



LED Spot Light



Model No: V-CLQ6607R	Surface Treatment: SL+HG/WH+SL
Power: COB 7W	Life Span: 30000H
Input Voltage: AC220-240V/50/60Hz	Material: Alum+PC+Glass
Luminous Flux: 560Lm	Working Temperature: -10~45° C
CRI: ≥80	IP: 20
Beam Angle: 38°	Body Size: Φ90*52mm
Color Temperature: 6500/4000/3000K	Hole Size: Φ80mm



V-CLQ6607R

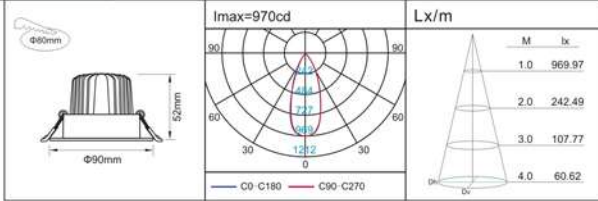

Products list

Model No.	Power	Luminous Flux	Beam angle	Surface	Body Size	Hole Size
V-CLQ6607R	COB 7W	560Lm	38°	SL+HG/WH+SL	Φ90x52mm	Φ80mm
V-CLQ6612R	COB 12W	960Lm	38°	SL+HG/WH+SL	Φ110x68mm	Φ95mm

Model No: V-0504	Surface Treatment: WH+HG
Power: COB 8W	Life Span: 30000H
Input Voltage: AC220-240V/50/60Hz	Material: Alum+PC+Glass
Luminous Flux: 620Lm	Working Temperature: -10~45° C
CRI: ≥70	IP: 20
Beam Angle: 60°	Body Size: Φ95*55mm
Color Temperature: 6500/4000/3000K	Hole Size: Φ85mm



V-0504

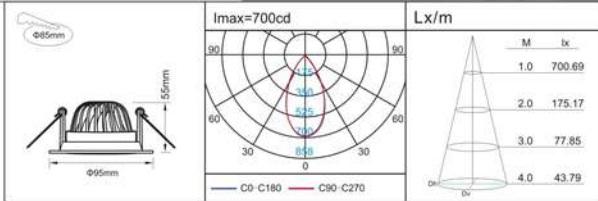

LED Spot Light



Model No: V-GLQ0515S-1B	Surface Treatment: WH
Power: COB 15W	Life Span: 30000H
Input Voltage: AC220-240V/50/60Hz	Material: Alum+PC
Luminous Flux: 1400Lm	Working Temperature: -10~45° C
CRI: ≥85	IP: 20
Beam Angle: 24°	Body Size: 116*116*98mm
Color Temperature: 6500/4000/3000K	Hole Size: 105*105mm



V-GLQ0515S-1B

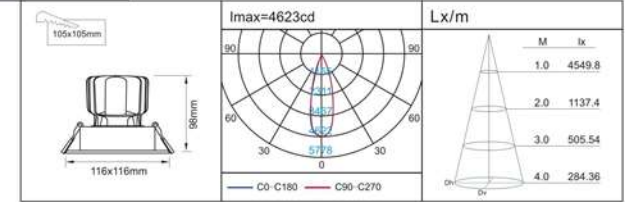

Products list

Model No.	Power	Luminous Flux	Beam angle	Surface	Body Size	Hole Size
V-GLQ0515S-1B	COB 15W	1400Lm	24°	WH	116x116x98mm	105x105mm
V-GLQ0515L-2B	COB 2x15W	2800Lm	2x24°	WH	214x116x98mm	200x105mm
V-GLQ0515L-3B	COB 3x15W	4300Lm	3x24°	WH	307x116x98mm	290x105mm
V-GLQ0530S-1B	COB 30W	3600Lm	24°	WH	176x176x138mm	160x160mm
V-GLQ0530L-2B	COB 2x30W	6000Lm	2x24°	WH	325x176x138mm	310x160mm
V-GLQ0530L-3B	COB 3x30W	9000Lm	3x24°	WH	475x176x138mm	460x160mm



Model No: V-PQ0745L	Surface Treatment: WH+HG
Power: COB 45W	Life Span: 30000H
Input Voltage: AC220-240V/50/60Hz	Material: Alum+PC+Glass
Luminous Flux: 3800Lm	Working Temperature: -10~45° C
CRI: ≥80	IP: 20
Beam Angle: 90°	Body Size: 245*153*145mm
Color Temperature: 6500/4000/3000K	Hole Size: 235*130mm



Model No: MD-PQ1040L	Surface Treatment: WH
Power: COB 40W	Life Span: 25000H
Input Voltage: AC220-240V/50/60Hz	Material: Alum+PC+Glass
Luminous Flux: 3100Lm	Working Temperature: -10~45° C
CRI: ≥80	IP: 20
Beam Angle: 100°	Body Size: 230*145*110mm
Color Temperature: 6500/4000/3000K	Hole Size: 220*130mm



Spot Light



Model No. V-CLM0009U V-CLM0009E	Surface Treatment: WH
Power: 14W/12W/8W	Life Span: 30000h
Input Voltage: AC220-240V/50/60Hz	Material: Alum/PC
Luminous Flux: 865lm	Working Temperature: -10~45° C
CRi: >95	CF: 30
Beam Angle: 7°	Body Size: Φ72mm
Cable Temperature: 0~2000000000K	Hole Size: 7°



Model No. V-CLM0009U	Surface Treatment: WH
Power: 8W/5W	Life Span: 30000h
Input Voltage: AC220-240V/50/60Hz	Material: Alum/PC
Luminous Flux: 565lm	Working Temperature: -10~45° C
CRi: >95	CF: 30
Beam Angle: 7°	Body Size: Φ72mm
Cable Temperature: 0~2000000000K	Hole Size: 7°



Model No. V-CLM0009U	Surface Treatment: WH
Power: 12W/8W	Life Span: 30000h
Input Voltage: AC220-240V/50/60Hz	Material: Alum/PC
Luminous Flux: 765lm	Working Temperature: -10~45° C
CRi: >95	CF: 30
Beam Angle: 7°	Body Size: Φ72mm
Cable Temperature: 0~2000000000K	Hole Size: 7°



Model No. V-0000	Surface Treatment: SL
Power: 14W/12W/8W	Life Span: 30000h
Input Voltage: AC220-240V/50/60Hz	Material: Alum/PC
Luminous Flux: 865lm	Working Temperature: -10~45° C
CRi: >95	CF: 30
Beam Angle: 45°	Body Size: Φ72mm
Cable Temperature: 0~2000000000K	Hole Size: Φ20mm

C.M.L.K.



Spot Light



Model No. V-3007A	Surface Treatment: WH
Power: COB 12W	Life Span: 30000h
Input Voltage: AC220-240V/50/60Hz	Material: Alum/PC
Luminous Flux: 865lm	Working Temperature: -10~45° C
CRi: >95	CF: 30
Beam Angle: 45°	Body Size: Φ87mm
Cable Temperature: 0~2000000000K	Hole Size: Φ6mm

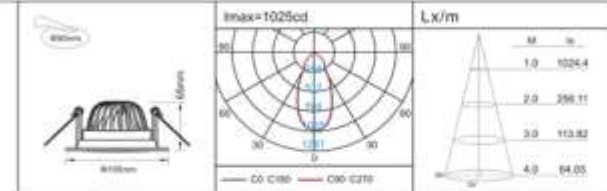
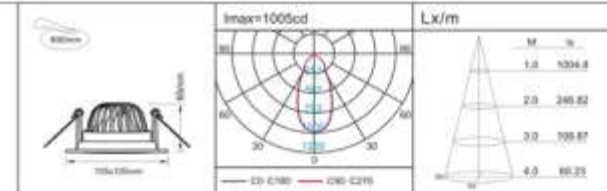
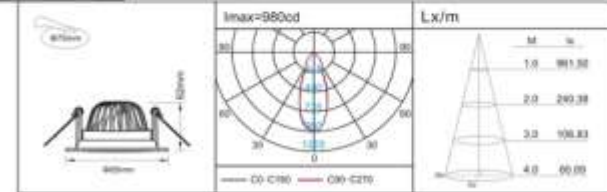

Products list

Model No.	Power	Luminous Flux	Beam angle	Surface	Body Size	Hole Size
V-3007A	COB 12W	865lm	45°	WH	Φ87x22mm	Φ7mm
V-3107A	COB 12W	865lm	45°	WH	Φ110x45mm	Φ8mm
V-3107A	COB 7W	865lm	45°	WH	Φ140x42mm	Φ7mm
V-1112A	COB 12W	865lm	45°	WH	100x100x40mm	Φ8mm
V-3207A	COB 7W	865lm	45°	WH	Φ80x22mm	Φ7mm
V-3210A	COB 12W	865lm	45°	WH	Φ110x22mm	Φ8mm
V-3210A-D	COB 12W	Dimmable 0~855lm	45°	WH	Φ110x45mm	Φ8mm

C.M.L.K.



Spot Light



Model No. MD-CL0230R	Surface Treatment: WH
Power: COB 3W	Life Span: 20000h
Input Voltage: AC220-240V/50/60Hz	Material: Alum+PC
Luminous Flux: 420lm	Working Temperature: -10~40° C
CRI: >80	IP: IP20
Beam Angle: 40°	Body Size: 86x42mm
Color Temperature: 6500K/4000K/3000K	Hole Size: 87mm



MD-CL0230R

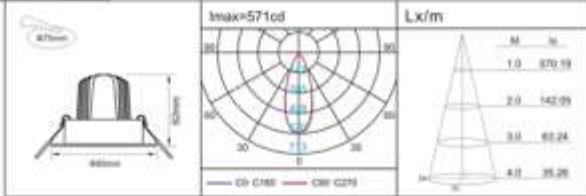

Products list

Model No.	Power	Luminous Flux	Beam angle	Surface	Body Size	Hole Size
MD-CL0230R	COB 3W	420lm	40°	WH	86x42mm	87mm
MD-CL0230R	COB 6W	720lm	40°	WH	86x62mm	88mm

Model No. MD-40000W	Surface Treatment: WH/WH
Power: COB 12W	Life Span: 20000h
Input Voltage: AC220-240V/50/60Hz	Material: Alum+Glass
Luminous Flux: 900lm	Working Temperature: -10~40° C
CRI: >80	IP: IP20
Beam Angle: 30°	Body Size: 86x70mm
Color Temperature: 6500K/4000K/3000K	Hole Size: 87mm



MD-40000W

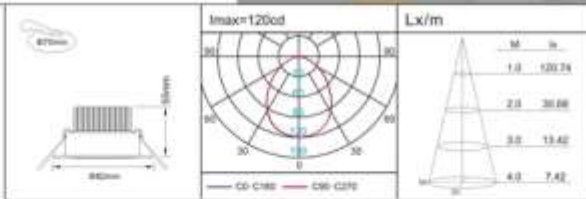

Products list

Model No.	Power	Luminous Flux	Beam angle	Surface	Body Size	Hole Size
MD-40000W-G-5-HG	COB 12W	800lm	50°	WH+WH/WH+HG	86x25mm	87mm
MD-40000W-G-5-HG	COB 18W	1020lm	50°	WH+SLHG	86x45mm	88mm
MD-40000W-G-5-HG-RF	COB 12W	900lm	30°	CCT (switch control)	86x25mm	87mm
MD-40000W-G-5-HG-RF	COB 18W	1020lm	30°	switch control + RGB	86x45mm	88mm



Spot Light



Model No. MD-CL0207R	Surface Treatment: WH
Power: COB 7W	Life Span: 20000h
Input Voltage: AC220-240V/50/60Hz	Material: Alum+Glass
Luminous Flux: 980lm	Working Temperature: -10~40° C
CRI: >80	IP: IP20
Beam Angle: 30°	Body Size: 86x55mm
Color Temperature: 6500K/4000K/3000K	Hole Size: 87mm



MD-CL0207R

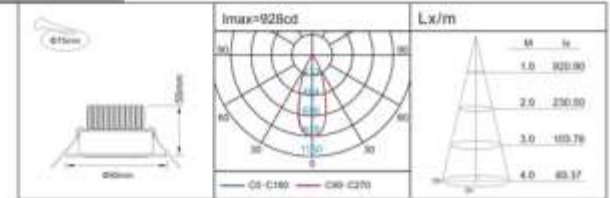

Products list

Model No.	Power	Luminous Flux	Beam angle	Surface	Body Size	Hole Size
MD-CL0207R	COB 7W	980lm	30°	WH	86x55mm	87mm
MD-CL0212R	COB 12W	1100lm	60°	WH	86x62mm	90mm
MD-CL0228R	COB 20W	1900lm	30°	WH	86x71mm	87mm

Model No. MD-F2412R	Surface Treatment: WH
Power: COB 12W	Life Span: 20000h
Input Voltage: AC220-240V/50/60Hz	Material: Alum+PC
Luminous Flux: 1100lm	Working Temperature: -10~40° C
CRI: >80	IP: IP20
Beam Angle: 18°	Body Size: 87x145mm
Color Temperature: 6500K/4000K/3000K	Hole Size: 87mm



MD-F2412R

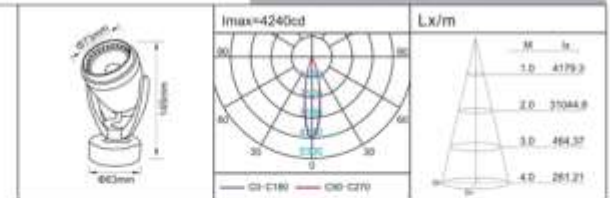

Products list

Model No.	Power	Luminous Flux	Beam angle	Surface	Body Size
MD-F2412R	COB 12W	1100lm	18°	WH	87x145mm
MD-F2430R	COB 30W	2400lm	18°	WH	87x208mm



Spot Light



Model No: V-1002
Power: Suitable of Lamp cup (M16)
Input Voltage: AC220-240V 50/60Hz
Surface Treatment: WH/SN/CB/EG/SBK
Body Size: Φ81*29mm
Hole Size: Φ75mm



Model No: V-PAR30-30W	Surface Treatment: WH
Power: COB 30W	Lamp Holder: E27/E52
Input Voltage: AC220-240V 50/60Hz	Life Span: 30000H
Luminous Flux: 2800lm	Material: Alum/PC
CR: >70	Working Temperature: -10~45° C
Beam Angle: 18°	Φ: 20
Color Temperature: 6500/4000/3000K	Body Size: Φ90*118mm

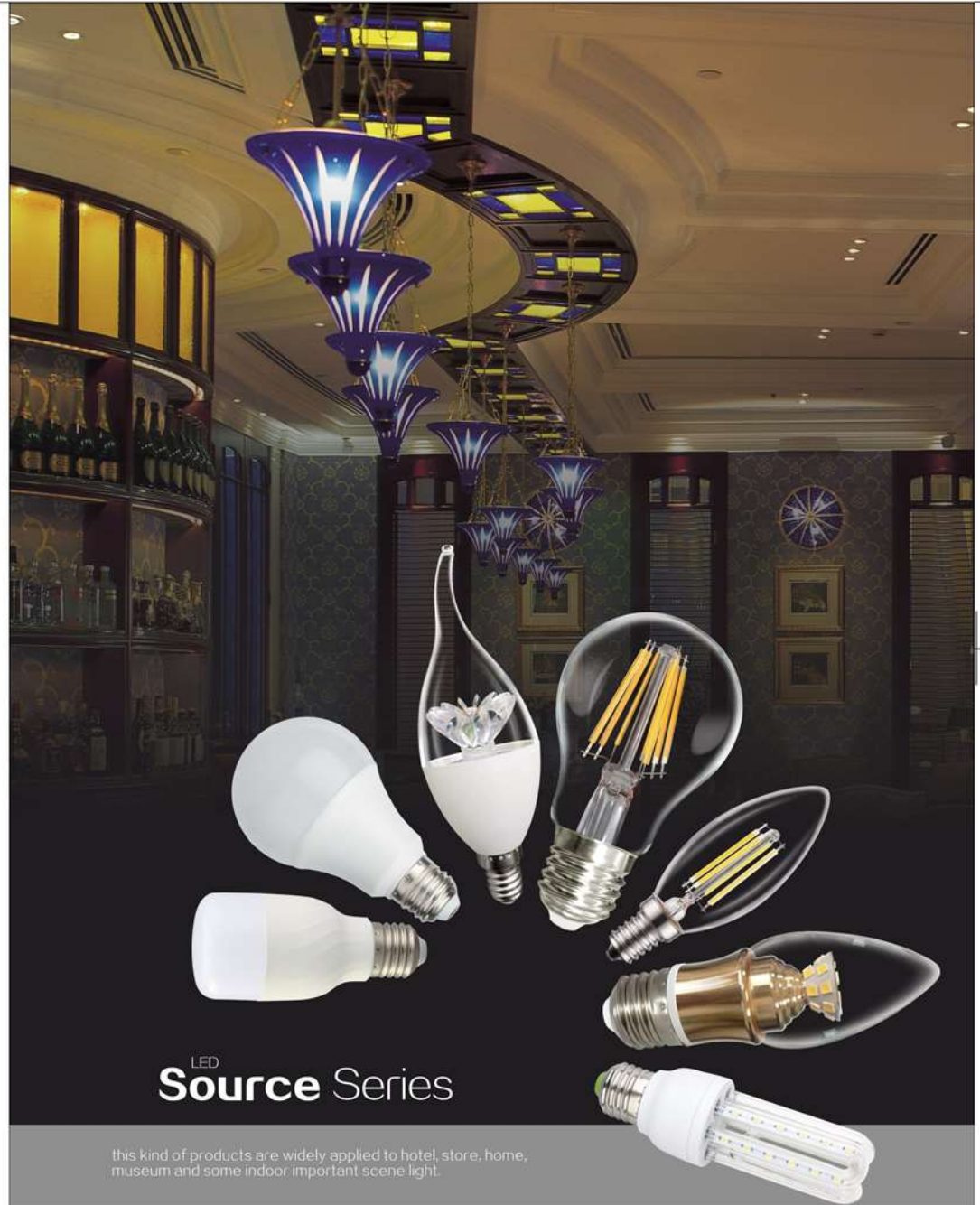

LED Source Series

this kind of products are widely applied to hotel, store, home, museum and some indoor important scene light.



LED FLOOD LIGHT HO-FL01



Product Size:

10W:	133*115*35mm
20W:	178*158*42mm
30W:	180*220*46mm
50W:	225*280*56mm
100W:	295*350*63mm
150W:	400*320*76mm
200W:	400*320*76mm

Available Power

10W 20W 30W 50W

100W 150W 200W

Product Feature

Dia-casting Aluminum with tempered glass.

50W equal to 200W traditional lamps under the same brightness.

Ultra-efficiency, long lifespan

Technical Data:

Model No.	HO-FL01
Working voltage:	100-277V
Operation Frequency:	50/60Hz
Lumen Efficiency:	> 110lm/W
Power Efficiency (PE %):	90%
IP rating:	IP65
Lifespan:	5,000Hrs
Operating Temperature	-35°C-50°C
LED Chip:	Epistar/LumiLEDs
LED Driver:	Isolated
Beam Angle:	120°
Warranty:	3/5 year

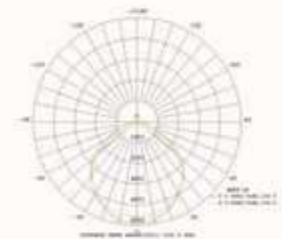
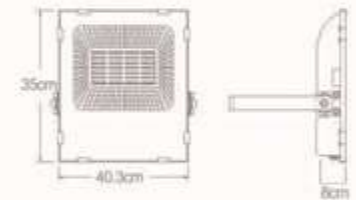

Application



Facade Lighting



Architectural Lighting



Industry



Billboard



Parking



LED FLOOD LIGHT HO-FL02



Available Power

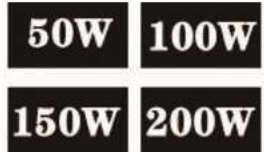

Product Size:

50W: 250*210*45mm
100W: 295*255*58mm
150W: 365*310*65mm
200W: 365*310*65mm

Product Feature

Dia-casting Aluminum with tempered glass.
50W equal to 200W traditional lamps under the same brightness.
Ultra-efficiency, long lifespan

Technical Data:

Model No. HO-FL02
Working voltage: 100-277V
Operation Frequency: 50/60Hz
Lumen Efficiency: > 110lm/W
Power Efficiency (PE %): 90%
IP rating: IP65
Lifespan: 5,000Hrs
Operating Temperature -35°C-50°C
LED Chip: Epistar/ LumiLEDS
LED Driver: Isolated
Beam Angle: 120°
Warranty: 3/5 year

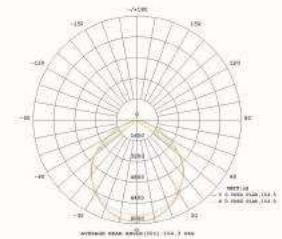

Application

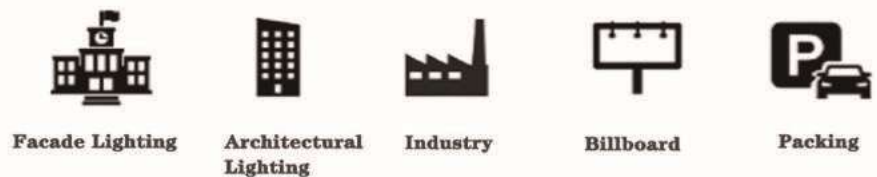



LED FLOOD LIGHT HO-FL03



Available Power

- 50W 100W
- 200W 300W

Product Size:

- 50W: 310*192*45mm
- 100W: 438*248*58mm
- 150W: 438*360*58mm
- 200W: 438*495*65mm

Product Feature

- Dia-casting Aluminum with tempered glass.
- 50W equal to 200W traditional lamps under the same brightness.
- Ultra-efficiency, long lifespan

Technical Data:

- Model No. HO-FL03
- Working voltage: 100-277V
- Operation Frequency: 50/60Hz
- Lumen Efficiency: > 110lm/W
- Power Efficiency (PE %): 90%
- IP rating: IP65
- Lifespan: 5,000Hrs
- Operating Temperature: -35°C-50°C
- LED Chip: Epistar/ LumiLEDs
- LED Driver: Isolated
- Beam Angle: 60° 90°
- Warranty: 3/5 year

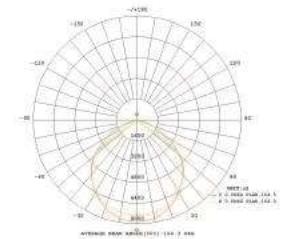
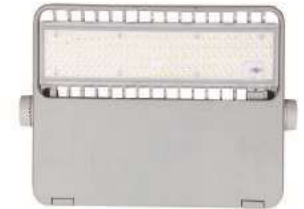

Application

- Facade Lighting
- Architectural Lighting
- Industry
- Billboard
- Packing



LED FLOOD LIGHT HO-FL04



Available Power

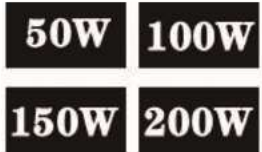

Product Size:

50W: 250*230*46mm
 100W: 286*267*56mm
 150W: 325*305*56mm
 200W: 382*362*61mm

Product Feature

Dia-casting Aluminum with tempered glass, Pc lens.
 Enviroment-friendly and energy saving, 90% compared with traditional lamps
 High Brightness, long lifespan over 50,000Hrs.

Technical Data:

Model No.	HO-FL04
Working voltage:	100-277V
Operation Frequency:	50/60Hz
Lumen Efficiency:	> 110lm/W
Power Efficiency (PE %):	90%
IP rating:	IP65
Lifespan:	5,000Hrs
Operating Temperature	-35°C-50°C
LED Chip:	Epistar/ LumiLEDs
LED Driver:	Isolated
Beam Angle:	120°
Warranty:	3/5 year

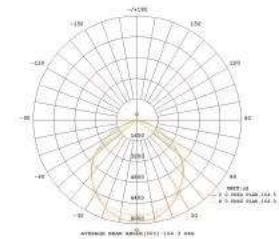
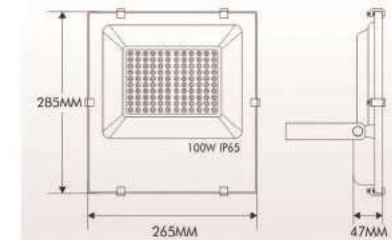

Application

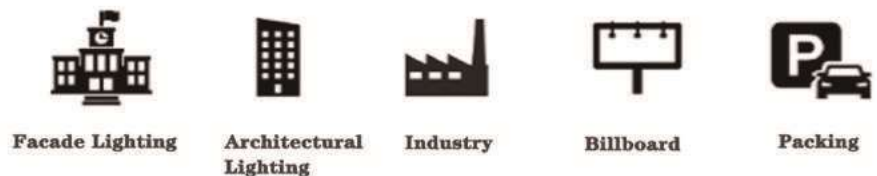



LED STREET LIGHT HO-SL01



Model No	Power	Efficiency	CRI	IP	Voltage	Warranty	Product Size
HO-SL01	50W	130lm/W	>80	IP67	AC100-277V	5 year	540*203*90mm
HO-SL01	100W	130lm/W	>80	IP67	AC100-277V	5 year	660*262*95mm
HO-SL01	150W	130lm/W	>80	IP67	AC100-277V	5 year	720*310*95mm
HO-SL01	200W	130lm/W	>80	IP67	AC100-277V	5 year	870*370*115mm

Description

High Lumen output LED
International 1.0 Rubber ring
Die-casting Aluminum construction for long durable life
IP67 dust tight and water jet proof for stay clean operation
Outstanding optical performance reduces installed points
Operating Temperature -30-50°C

Light Engine and Control Gear

High efficiency SMD LED light engines
>80 CRI 2700-6500K
Energy Efficient LED system

Materials

Die-casting Aluminum body good for heat dissipation.
Polycarbonate UV stabilised lens 90° 120° available



LUMILEDS NICHIA

2700-3500K Warm White
4000-4500K Neutral White
5700-6500K Cool White

Driver:



PHILIPS

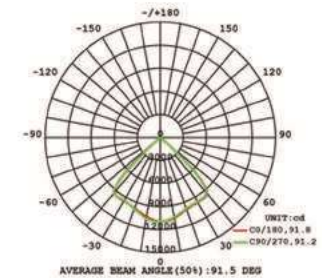
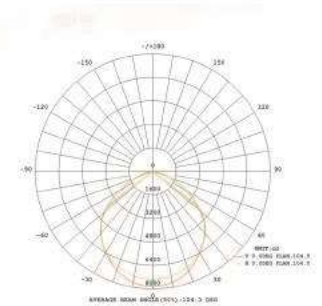

Application



Highway



Walkway



Street



Parking



Park & Square



LED STREET LIGHT HO-SL02

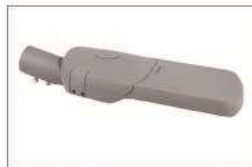

Description

High Lumen output SMD LED 3030
International 1.0 Rubber ring
Mainly application for highway, street and parking place
IP67 dust tight and water jet proof for stay clean operation
Outstanding optical performance reduces installed points
Operating Temperature -30-50°C

Light Engine and Control Gear

High efficiency SMD LED over 130lm/W
>80 CRI 2700-6500K
Energy Efficient LED system with temperature control

Materials

6063 Pure Aluminum body good for heat dissipation.
Polycarbonate UV stabilised lens 90° 120° available



LUMILEDS **NICHIA**

2700-3500K Warm White
4000-4500K Neutral White
5700-6500K Cool White

Driver:



PHILIPS

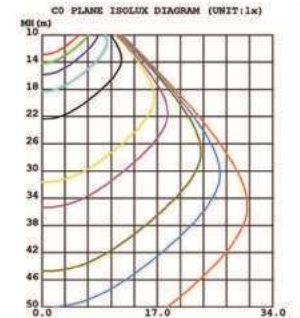
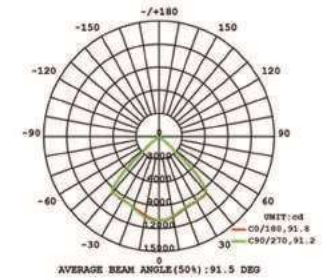

Model No	Power	Efficiency	CRI	IP	Voltage	Warranty	Product Size
HO-SL02	50W	130lm/W	>80	IP67	AC100-277V	5 year	610*260*135mm
HO-SL02	100W	130lm/W	>80	IP67	AC100-277V	5 year	660*280*135mm
HO-SL02	150W	130lm/W	>80	IP67	AC100-277V	5 year	710*290*135mm

Application



Highway



Walkway



Street



Parking



Park & Square



LED STREET LIGHT HO-SL03



Model No	Power	Efficiency	CRI	IP	Voltage	Warranty	Product Size
HO-SL03	100W	130lm/W	>80	IP65	AC100-277V	5 year	422*320*140mm
HO-SL03	180W	130lm/W	>80	IP65	AC100-277V	5 year	522*320*140mm
HO-SL03	240W	130lm/W	>80	IP65	AC100-277V	5 year	650*320*140mm
HO-SL03	320W	130lm/W	>80	IP65	AC100-277V	5 year	855*320*140mm

Description

Unique design led flood light, project first selection
 International 1.0 Rubber ring
 Mainly application for highway, street, walkway and parking place
 IP67 dust tight and water jet proof for stay clean operation
 Outstanding optical performance reduces installed points
 Operating Temperature -30-50°C

Light Engine and Control Gear

High efficiency SMD LED over 130lm/W
 >80 CRI 2700-6500K
 Energy Efficient LED system with temperature control

Materials

6063 Pure Aluminum body good for heat dissipation.
 Polycarbonate UV stabilised lens 135*70° available



LUMILEDS **NICHIA**

2700-3500K Warm White
 4000-4500K Neutral White
 5700-6500K Cool White

Driver:



PHILIPS

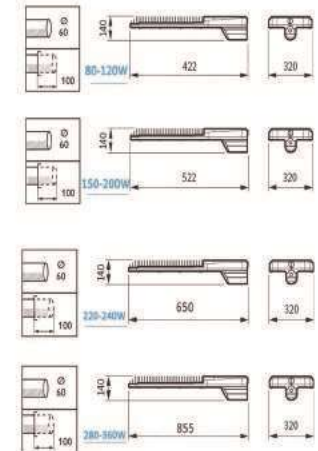

Application



Highway



Walkway



Street



Parking



Park & Square



LED STREET LIGHT HO-SL04



Model No	Power	Efficiency	CRI	IP	Voltage	Warranty	Product Size
HO-SL04	50W	130lm/W	>80	IP67	AC100-277V	5 year	530*350*90mm
HO-SL04	100W	130lm/W	>80	IP67	AC100-277V	5 year	610*350*90mm
HO-SL04	150W	130lm/W	>80	IP67	AC100-277V	5 year	690*350*90mm
HO-SL04	200W	130lm/W	>80	IP67	AC100-277V	5 year	770*350*90mm
HO-SL04	250W	130lm/W	>80	IP67	AC100-277V	5 year	850*350*90mm
HO-SL04	300W	130lm/W	>80	IP67	AC100-277V	5 year	930*350*90mm

Description

Unique design led flood light, project first selection
 International 1.0 Rubber ring
 Mainly application for highway, street, walkway and parking place
 IP67 dust tight and water jet proof for stay clean operation
 Outstanding optical performance reduces installed points
 Operating Temperature -30-50°C

Light Engine and Control Gear

High efficiency SMD LED over 130lm/W
 >80 CRI 2700-6500K
 Energy Efficient LED system with temperature control

Materials

6063 Pure Aluminum body good for heat dissipation.
 Polycarbonate UV stabilised lens 90° 120° available



LUMILEDS **NICHIA**

2700-3500K Warm White
 4000-4500K Neutral White
 5700-6500K Cool White

Driver:



PHILIPS

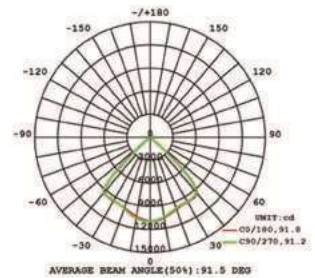
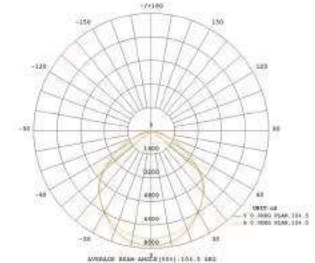

Application



Highway



Walkway



Street



Parking



Park & Square



LED STREET LIGHT

HO-SL05

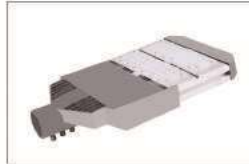

Description

Unique design led flood light, project first selection
 International 1.0 Rubber ring
 Mainly application for highway, street, walkway and parking place
 IP67 dust tight and water jet proof for stay clean operation
 Outstanding optical performance reduces installed points
 Operating Temperature -30-50°C

Light Engine and Control Gear

High efficiency SMD LED over 130lm/W
 >80 CRI 2700-6500K
 Energy Efficient LED system with temperature control

Materials

6063 Pure Aluminum body good for heat dissipation.
 Polycarbonate UV stabilised lens 90° 120° available



LUMILEDS **NICHIA**

2700-3500K Warm White
 4000-4500K Neutral White
 5700-6500K Cool White

Driver:



PHILIPS

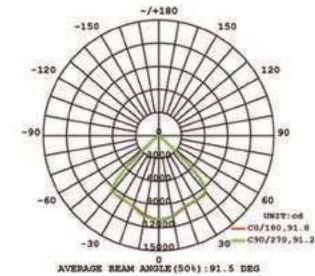
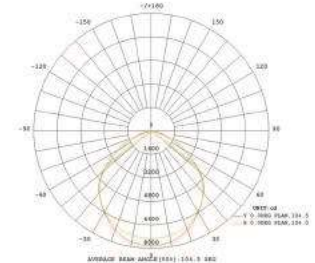

Model No	Power	Efficiency	CRI	IP	Voltage	Warranty	Product Size
HO-SL05	100W	130lm/W	>80	IP67	AC100-277V	5 year	480*310*80mm
HO-SL05	150W	130lm/W	>80	IP67	AC100-277V	5 year	560*310*80mm
HO-SL05	200W	130lm/W	>80	IP67	AC100-277V	5 year	640*310*80mm
HO-SL05	250W	130lm/W	>80	IP67	AC100-277V	5 year	720*310*80mm
HO-SL05	300W	130lm/W	>80	IP67	AC100-277V	5 year	780*310*80mm

Application



Highway



Walkway



Street



Parking



Park & Square



ECONOMICAL STREET LIGHT

HO-SL07



Model No	Power	Efficiency	CRI	IP	Voltage	Warranty	Product Size
HO-SL07	30W	110lm/W	>80	IP65	AC100-277V	3 year	351*142*76mm
HO-SL07	50W	110lm/W	>80	IP65	AC100-277V	3 year	405*166*79mm
HO-SL07	100W	110lm/W	>80	IP65	AC100-277V	3 year	484*211*83mm
HO-SL07	150W	110lm/W	>80	IP65	AC100-277V	3 year	580*242*83mm

ECONOMICAL STREET LIGHT

HO-SL08



Model No	Power	Efficiency	CRI	IP	Voltage	Warranty	Product Size
HO-SL08	30W	110lm/W	>80	IP65	AC100-277V	3 year	445*155*66mm
HO-SL08	50W	110lm/W	>80	IP65	AC100-277V	3 year	550*200*75mm
HO-SL08	100W	110lm/W	>80	IP65	AC100-277V	3 year	700*245*100mm
HO-SL08	150W	110lm/W	>80	IP65	AC100-277V	3 year	770*280*100mm



LED STREET LIGHT HO-SL10



Description

Unique design led flood light, project first selection
 International 1.0 Rubber ring
 Mainly application for highway, street, walkway and parking place
 IP67 dust tight and water jet proof for stay clean operation
 Outstanding optical performance reduces installed points
 Operating Temperature -30-50°C

Light Engine and Control Gear

High efficiency COB LED over 100lm/W
 >80 CRI 2700-6500K
 Energy Efficient LED system with temperature control
 Meanwell driver warranty 5 year



Model No	Power	Efficiency	CRI	IP	Voltage	Warranty	Product Size
HO-SL10	50W	100lm/W	>80	IP67	AC100-277V	5 year	490*260*75mm
HO-SL10	100W	100lm/W	>80	IP67	AC100-277V	5 year	565*260*75mm
HO-SL10	150W	100lm/W	>80	IP67	AC100-277V	5 year	710*260*77mm

Application



Highway



Walkway



Street



Parking



Park & Square



LED High Bay LIGHT HO-HB01

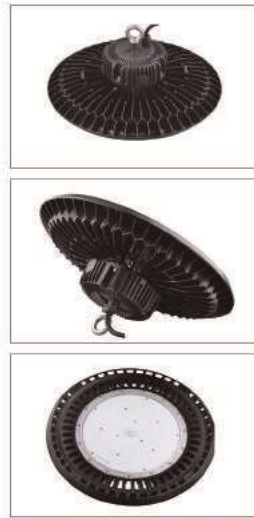

Model No	Power	Efficiency	CRI	IP	Voltage	Warranty	Product Size
HO-HB01	100W	130lm/W	>80	IP65	AC100-277V	3/5 year	280*280*50mm
HO-HB01	150W	130lm/W	>80	IP65	AC100-277V	3/5 year	340*340*50mm
HO-HB01	200W	130lm/W	>80	IP65	AC100-277V	3/5 year	400*400*56mm



Product Feature

Philips driver with LumiLEDs 3030 chip, warranty 5 year
 100W equal to 800W traditional lamps under the same brightness.
 Ultra-efficiency, long lifespan

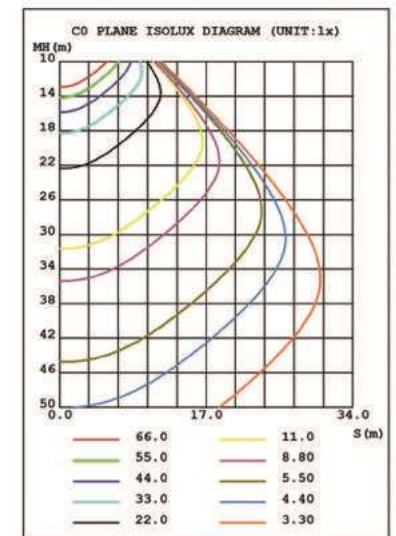
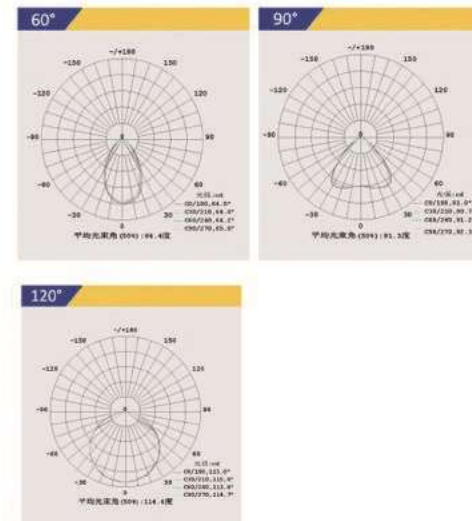

Application



Supermarket



Parking



Warehouse



Industry



Workshop



LED High Bay LIGHT HO-HB02



Product Feature

- Dia-casting Aluminum with tempered glass.
- 100W equal to 800W traditional lamps under the same brightness.
- Ultra-efficiency, long lifespan

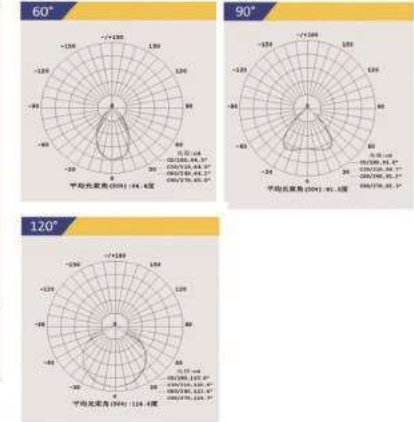
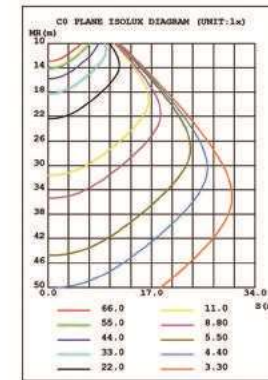
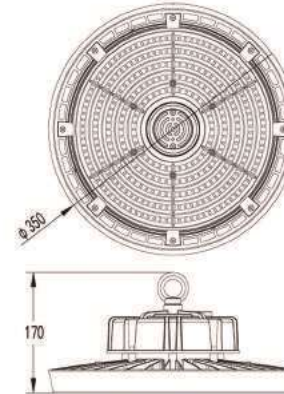

Model No	Power	Efficiency	CRI	IP	Voltage	Warranty	Product Size
HO-HB02	100W	130lm/W	>80	IP65	AC100-277V	3/5 year	φ280*160mm
HO-HB02	150W	130lm/W	>80	IP65	AC100-277V	3/5 year	φ315*160mm
HO-HB02	200W	130lm/W	>80	IP65	AC100-277V	3/5 year	φ350*170mm

Application



Supermarket



Parking



Warehouse



Industry



Workshop



LED High Bay LIGHT HO-HB03

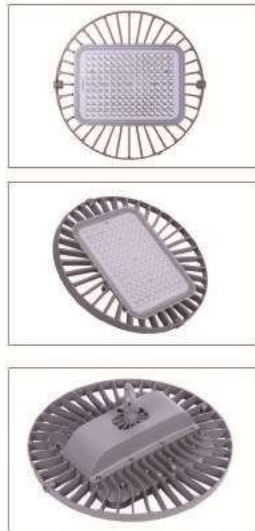

Model No	Power	Efficiency	CRI	IP	Voltage	Warranty	Product Size
HO-HB03	100W	130lm/W	>80	IP65	AC100-277V	3/5 year	φ380*115mm
HO-HB03	150W	130lm/W	>80	IP65	AC100-277V	3/5 year	φ420*115mm



Product Feature

Philips driver with LumiLEDs 3030 chip, warranty 5 year
 100W equal to 800W traditional lamps under the same brightness.
 Ultra-efficiency, long lifespan

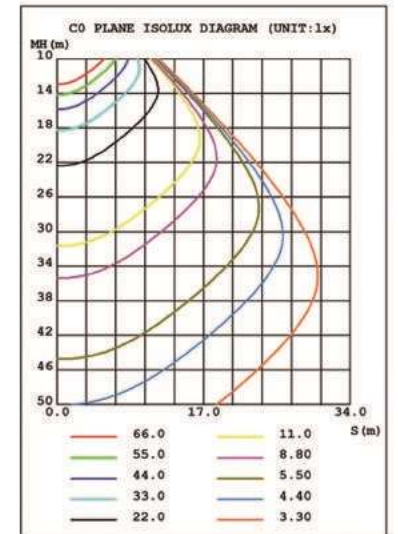
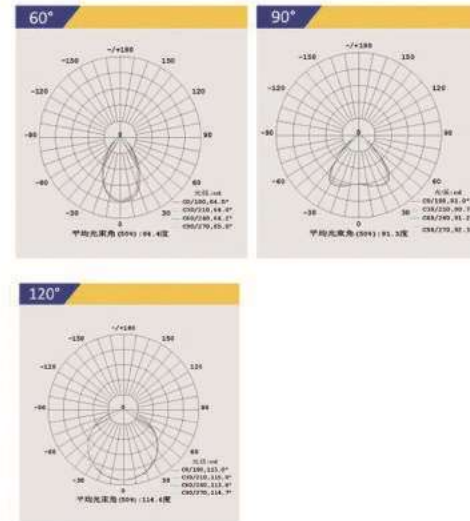

Application



Supermarket



Parking



Warehouse



Industry



Workshop



LED LINEAR HIGH BAY HO-HB04



Product Feature

Philips driver with LumiLEDs 3030 chip, warranty 5 year
50W equal to 400W traditional lamps under the same brightness.
Ultra-efficiency, long lifespan high PF

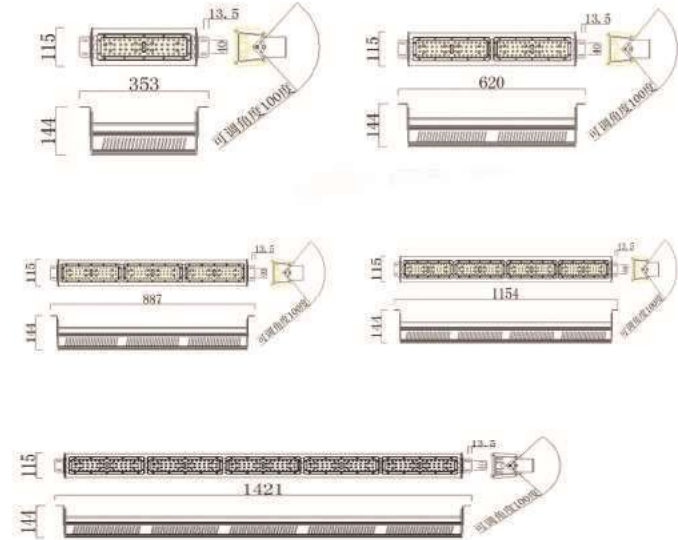
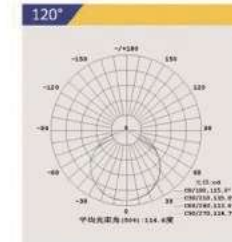
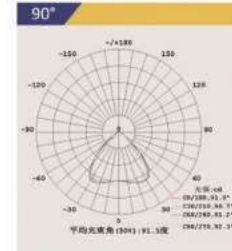

Application



Supermarket



Parking



Warehouse



Industry



Workshop

Model No	Power	Efficiency	CRI	IP	Voltage	Warranty	Product Size
HO-HB04	50W	130lm/W	>80	IP65	AC100-277V	5 year	353*144*115mm
HO-HB04	100W	130lm/W	>80	IP65	AC100-277V	5 year	620*144*115mm
HO-HB04	150W	130lm/W	>80	IP65	AC100-277V	5 year	887*144*115mm
HO-HB04	200W	130lm/W	>80	IP65	AC100-277V	5 year	1154*144*115mm
HO-HB04	250W	130lm/W	>80	IP65	AC100-277V	5 year	1420*144*115mm
HO-HB04	300W	130lm/W	>80	IP65	AC100-277V	5 year	947*230*275mm
HO-HB04	400W	130lm/W	>80	IP65	AC100-277V	5 year	1214*230*275mm
HO-HB04	500W	130lm/W	>80	IP65	AC100-277V	5 year	1481*230*275mm





LED TUNNEL LIGHT HO-TL01



Model No	Power	Efficiency	CRI	IP	Voltage	Warranty	Product Size
HO-TL01	50W	130lm/W	>80	IP65	AC100-277V	5 year	305*70*70mm
HO-TL01	100W	130lm/W	>80	IP65	AC100-277V	5 year	305*70*150mm
HO-TL01	150W	130lm/W	>80	IP65	AC100-277V	5 year	305*70*230mm
HO-TL01	200W	130lm/W	>80	IP65	AC100-277V	5 year	305*70*230mm
HO-TL01	250W	130lm/W	>80	IP65	AC100-277V	5 year	305*70*390mm
HO-TL01	300W	130lm/W	>80	IP65	AC100-277V	5 year	305*70*473mm
HO-TL01	400W	130lm/W	>80	IP65	AC100-277V	5 year	615*70*312mm



Description

- High Lumen output LED
- International 1.0 Rubber ring
- Die-casting Aluminum construction for long durable life
- IP65 dust tight and water jet proof for stay clean operation
- Outstanding optical performance reduces installed points
- Operating Temperature -30-50°C

Light Engine and Control Gear

- High efficiency SMD LED light engines
- >80 CRI 2700-6500K
- Energy Efficient LED system

Materials

- Die-casting Aluminum body good for heat dissipation.
- Polycarbonate UV stabilised lens 90° 120° available

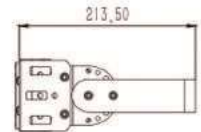
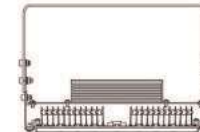
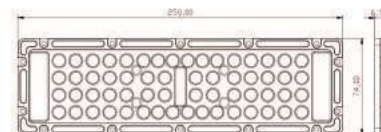
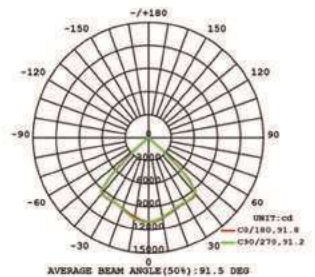
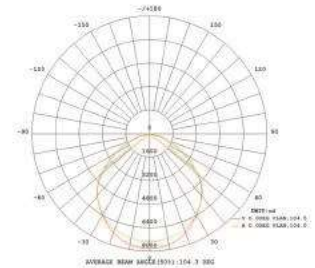



LED TUNNEL LIGHT HO-TL02



Model No	Power	Efficiency	CRI	IP	Voltage	Warranty	Product Size
HO-TL02	100W	130lm/W	>80	IP65	AC100-277V	5 year	300*360*140mm
HO-TL02	150W	130lm/W	>80	IP65	AC100-277V	5 year	400*360*140mm
HO-TL02	200W	130lm/W	>80	IP65	AC100-277V	5 year	500*360*140mm
HO-TL02	250W	130lm/W	>80	IP65	AC100-277V	5 year	600*360*140mm



Description

High Lumen output LED
International 1.0 Rubber ring
Die-casting Aluminum construction for long durable life
IP65 dust tight and water jet proof for stay clean operation
Outstanding optical performance reduces installed points
Operating Temperature -30-50°C

Light Engine and Control Gear

High efficiency SMD LED light engines
>80 CRI 2700-6500K
Energy Efficient LED system

Materials

Die-casting Aluminum body good for heat dissipation.
Polycarbonate UV stabilised lens 90° 120° available

Instruction

Suitable for column, wall and floor mounting
Front lens secured by latching clip
Supplied complete with 1m 3 core 1mm² lead

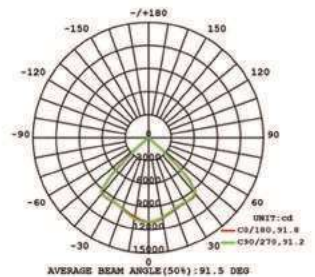
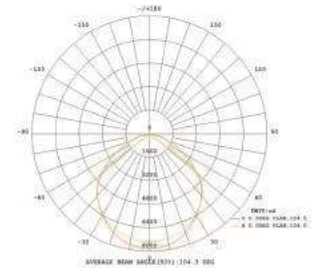



LED GAS STATION LIGHT HO-TL03

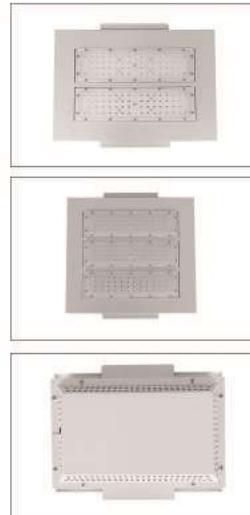

Description

High Lumen output LED
 International 1.0 Rubber ring
 Die-casting Aluminum construction for long durable life
 IP65 dust tight and water jet proof for stay clean operation
 Outstanding optical performance reduces installed points
 Operating Temperature -30-50°C

Light Engine and Control Gear

High efficiency SMD LED light engines
 >80 CRI 2700-6500K
 Energy Efficient LED system

Materials

Die-casting Aluminum body good for heat dissipation.
 Polycarbonate UV stabilised lens 90° 120° available

Instruction

Suitable for column, wall and floor mounting
 Front lens secured by latching clip
 Supplied complete with 1m 3 core 1mm² lead

Model No	Power	Efficiency	CRI	IP	Voltage	Warranty	Product Size
HO-TL03	100W	130lm/W	>80	IP65	AC100-277V	5 year	335*245*90mm
HO-TL03	150W	130lm/W	>80	IP65	AC100-277V	5 year	335*335*90mm
HO-TL03	200W	130lm/W	>80	IP65	AC100-277V	5 year	400*340*90mm





LED GAS STATION LIGHT

HO-TL04

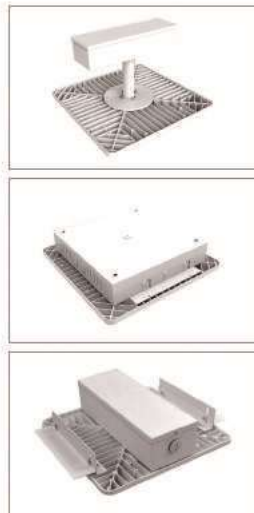

Description

- High Lumen output LED
- International 1.0 Rubber ring
- Die-casting Aluminum construction for long durable life
- IP65 dust tight and water jet proof for stay clean operation
- Outstanding optical performance reduces installed points
- Operating Temperature -30-50°C

Light Engine and Control Gear

- High efficiency SMD LED light engines
- >80 CRI 2700-6500K
- Energy Efficient LED system

Materials

- Die-casting Aluminum body good for heat dissipation.
- Polycarbonate UV stabilised lens 90° 120° available

Instruction

- Suitable for column, wall and floor mounting
- Front lens secured by latching clip
- Supplied complete with 1m 3 core 1mm² lead

Model No	Power	Efficiency	CRI	IP	Voltage	Warranty	Product Size
HO-TL04	60W	130lm/W	>80	IP65	AC100-277V	5 year	280*280mm
HO-TL04	80W	130lm/W	>80	IP65	AC100-277V	5 year	280*280mm
HO-TL04	100W	130lm/W	>80	IP65	AC100-277V	5 year	382*382 mm
HO-TL04	120W	130lm/W	>80	IP65	AC100-277V	5 year	382*382 mm
HO-TL04	150W	130lm/W	>80	IP65	AC100-277V	5 year	382*382 mm



*Pathways, Walkways, Park
and Small & Big areas*



	Watt	L	H
A	15W	φ150mm	600mm

Model No. HO-PL-02

Material: Aluminum + Painting
Power: COB*15W
Lift: Greater than 50,000 hours

Available finishing: Sand Black/ Sand Grey

Color Temperature:

- 3000K Warm White, 2700K Warm White,
- 5000K Neutral White, Amber



	Watt	L	H
A	12W	φ50mm	300mm
B	12W	φ50mm	600mm

Model No. HO-PL-01

Material: Aluminum + Acrylic
Power: COB*12W
Lift: Greater than 50,000 hours
Voltage: 12V 220V

Available finishing: Sand Black/ Sand Grey

Color Temperature:

- 3000K Warm White, 2700K Warm White,
- 5000K Neutral White, Amber

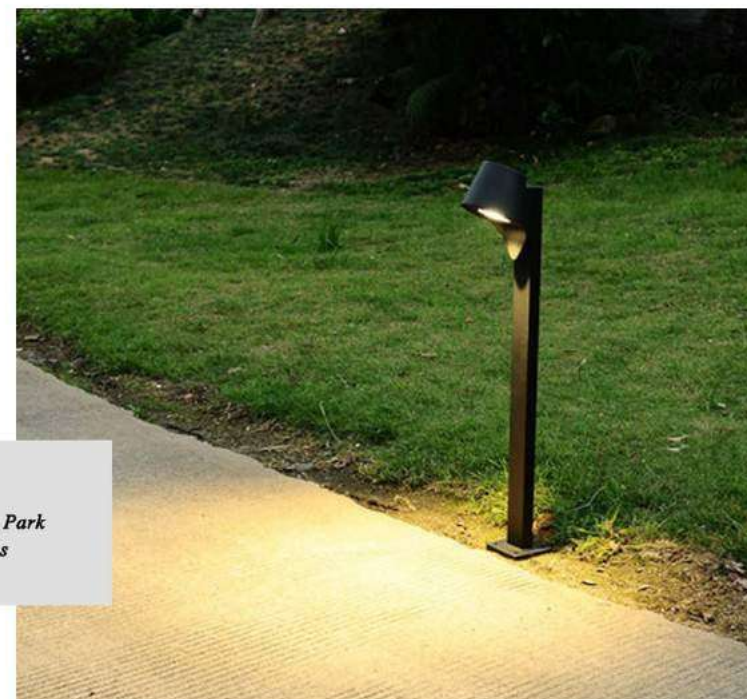

*Pathways, Walkways, Park
and Small & Big areas*



*Pathways, Walkways, Park
and Small & Big areas*



	Watt	L	H
A	10W	φ120mm	600mm

Model No. HO-PL-04

Material: Aluminum + Painting

Power: COB*10W

Lift: Greater than 50,000 hours

Voltage: 110-20V 50/60Hz

Available finishing: Sand Black/ Sand Grey

Color Temperature:

3000K Warm White, 2700K Warm White,
5000K Neutral White, Amber



	Watt	L	W	H
A	10W	120mm	120mm	450mm

Model No. HO-PL-03

Material: Dia- casting Aluminum

Power: COB*10W

Lift: Greater than 50,000 hours

Voltage: 110-200V 50/60Hz

Available finishing: Sand Black/ Sand Grey

Color Temperature:

3000K Warm White, 2700K Warm White,
5000K Neutral White, Amber



*Pathways, Walkways, Park
and Small & Big areas*

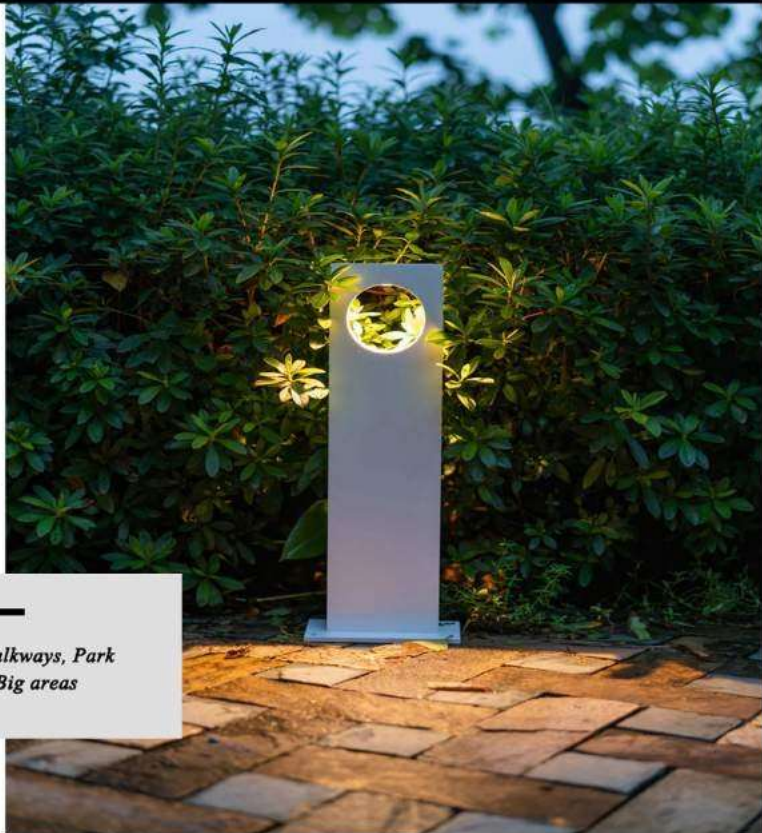

Pathways, Walkways, Park and Small & Big areas

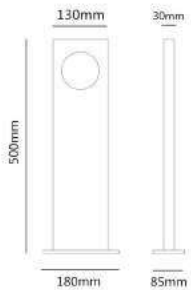

Model No. HO-PL-05

Material: Dia- casting Aluminum
Power: COB*10W
Lift: Greater than 50,000 hours
Voltage: 110-220V 50/60Hz

Available finishing: Sand Black/ Sand Grey

Color Temperature:
3000K Warm White, 2700K Warm White,
5000K Neutral White, Amber



Model No. HO-PL-06

Material: Aluminum + Acrylic Cver
Power: COB*6W
Lift: Greater than 50,000 hours
Voltage: 110-220V 50/60Hz

Available finishing: Sand Black/ Sand Grey

Color Temperature:
3000K Warm White, 2700K Warm White,
5000K Neutral White, Amber



Φ90mm

HO-PL06-A



Φ108mm

HO-PL06-B



Φ150mm

HO-PL06-C

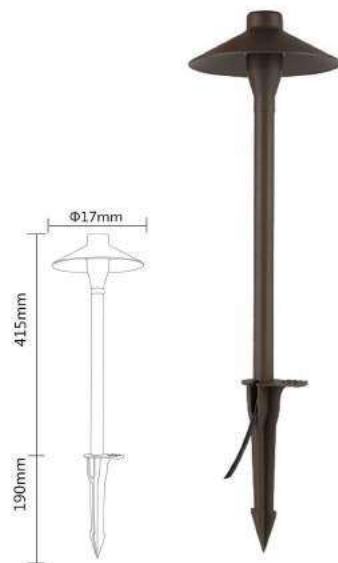

Model No. HO-PL-07-A

Material: Aluminum + Acrylic Cver
Power: COB*10W
Lift: Greater than 50,000 hours
Voltage: AC110-220V 50/60Hz

Available finishing: Sand Black/ Sand Grey/Customized

Color Temperature:

- 3000K Warm White, 2700K Warm White,
- 5000K Neutral White, Amber

*Pathways, Walkways, Park
and Small & Big areas*



Model No. HO-PL-07-B

Material: Dia- casting Aluminum
Power: COB*10W
Lift: Greater than 50,000 hours
Voltage: 110-220V 50/60Hz

Available finishing: Sand Black/ Sand Grey/Customized

Color Temperature:

- 3000K Warm White, 2700K Warm White,
- 5000K Neutral White, Amber

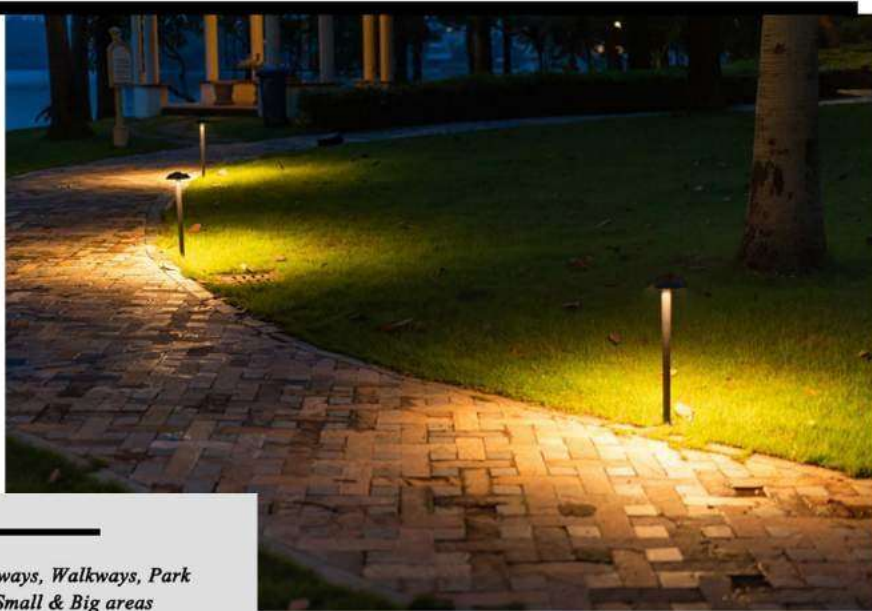

Pathways, Walkways, Park and Small & Big areas



Model No. HO-PL-08

Material: Dia-casting Aluminum
Power: COB*5W
Lift: Greater than 50,000 hours
Voltage: 110-220V 50/60Hz

Available finishing: Sand Black/ Sand Grey/Customized

Color Temperature:

- 3000K Warm White, 2700K Warm White,
- 5000K Neutral White, Amber



Model No. HO-PL-07

Material: Dia- casting Aluminum
Power: 12W
Lift: Greater than 50,000 hours
Voltage: 110-220V 50/60Hz

Available finishing: Sand Black/ Sand Grey/ Customized

Color Temperature:

- 3000K Warm White, 2700K Warm White,
- 5000K Neutral White, Amber

Pathways, Walkways, Park and Small & Big areas

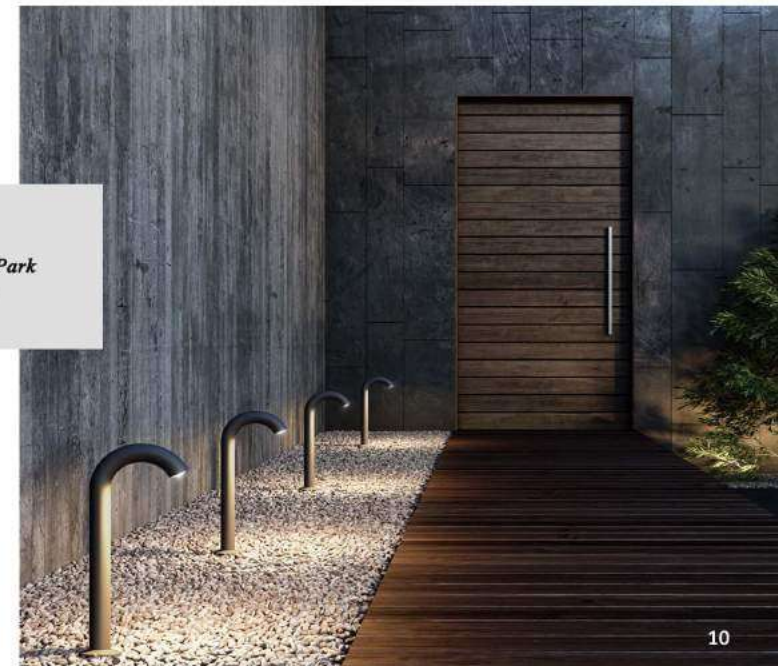



*Pathways, Walkways, Park
and Small & Big areas*



Model	Watt	Dia	H
HO-PL-10-A	10W	φ125mm	300mm
HO-PL-10-B	10W	φ125mm	600mm
HO-PL-10-C	10W	φ125mm	900mm

Model No: HO-PL-10

Material: Aluminum + Painting
Power: COB*10W
Lift: Greater than 50,000 hours
Voltage: 110-220V 50/60Hz

Available finishing: Sand Black/ Sand Grey

Color Temperature:

- 3000K Warm White, 2700K Warm White,
- 5000K Neutral White, Amber



Model	Watt	Dia	H
HO-PL-09-A	10W	φ105mm	400mm
HO-PL-09-B	10W	φ105mm	600mm

Model No: HO-PL-09-A

Material: Aluminum + Acrylic
Power: COB*10W
Lift: Greater than 50,000 hours
Voltage: 110-220V 50/60Hz

Available finishing: Sand Black/ Sand Grey

Color Temperature:

- 3000K Warm White, 2700K Warm White,
- 5000K Neutral White, Amber

Model	Watt	Dia	H
HO-PL-12-A	10W	φ125mm	600mm
HO-PL-12-B	10W	φ125mm	900mm

Model No: HO-PL-11

Material: Aluminum + Painting
Power: COB*10W
Lift: Greater than 50,000 hours
Voltage: 110-220V 50/60Hz

Available finishing: Sand Black/ Sand Grey

Color Temperature:

- 3000K Warm White, 2700K Warm White,
- 5000K Neutral White, Amber





*Pathways, Walkways, Park
and Small & Big areas*



Model	Watt	Dia	H
HO-PL-13-A	20W	φ145mm	1500mm
HO-PL-13-B	30W	φ145mm	2000mm
HO-PL-13-C	30W	φ145mm	2500mm
HO-PL-13-D	30W	φ145mm	3000mm

Model No: HO-PL-13-A

Round / Square model are available
 Material: Aluminum + Painting
 Power: COB* 20-30W
 Lift: Greater than 50,000 hours

Color Temperature:
 3000K Warm White, 2700K Warm White,
 5000K Neutral White, Amber

Available finishing: Sand Black/ Sand Grey



Pathways, Walkways, Park and Small & Big areas

Model No. HO-UL-02

Material: Aluminum + Painting
 Power: COB*10W
 Lift: Greater than 50,000 hours
 Voltage: 110-200V 50/60Hz

Available finishing: Sand Black/ Sand Grey

Color Temperature:

- 3000K Warm White, 2700K Warm White,
- 5000K Neutral White, Amber



Model: HO-UL-01-A/B

Material: Dia- casting Aluminum
 Power: SMD *10W
 Lift: Greater than 50,000 hours
 Voltage: 110-200V 50/60Hz

Available finishing: Sand Black/ Sand Grey

Color Temperature:

- 3000K Warm White, 2700K Warm White,
- 5000K Neutral White, Amber



Pathways, Walkways, Park and Small & Big areas

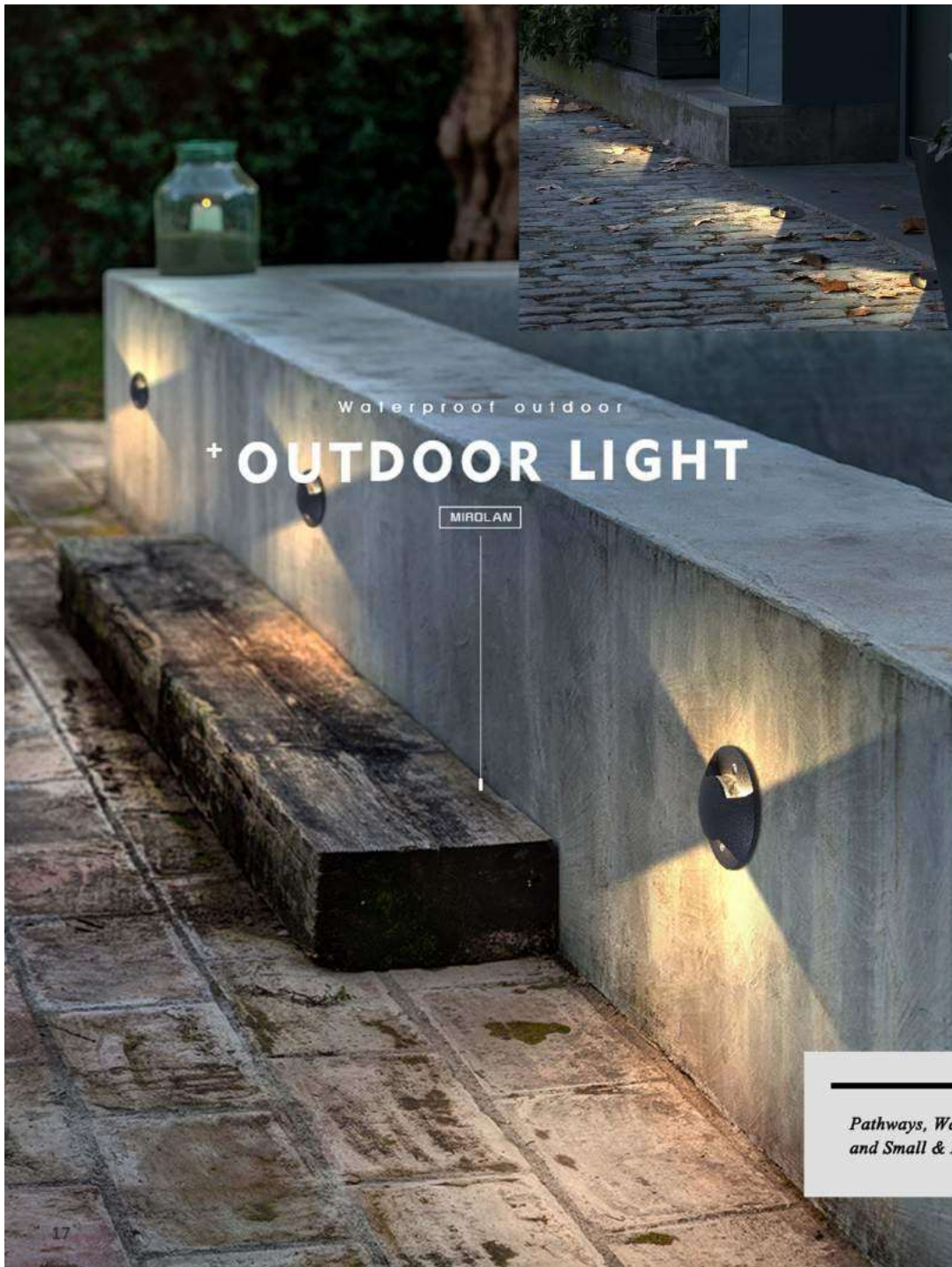

Waterproof outdoor
+ OUTDOOR LIGHT

MIROLAN

*Pathways, Walkways, Park
and Small & Big areas*



Model No. HO-UL03-A

Material: Aluminum + Painting
Power: COB*1 2W
Lift: Greater than 50,000 hours
Product Size: $\phi 67.5 * H90mm$

Available finishing: Sand Black/ Sand Grey

Color Temperature:

- 3000K Warm White, 2700K Warm White,
- 5000K Neutral White, Amber



Model No. HO-UL03-B

Material: Aluminum + Painting
Power: COB*1 2W
Lift: Greater than 50,000 hours
Product Size: $\phi 67.5 * H90mm$

Available finishing: Sand Black/ Sand Grey

Color Temperature:

- 3000K Warm White, 2700K Warm White,
- 5000K Neutral White, Amber



Model No. HO-UL03-C

Material: Aluminum + Painting
Power: COB*1 2W
Lift: Greater than 50,000 hours
Product Size: $\phi 67.5 * H90mm$

Available finishing: Sand Black/ Sand Grey

Color Temperature:

- 3000K Warm White, 2700K Warm White,
- 5000K Neutral White, Amber



Model No. HO-UL-04-A

Material: Aluminum + Painting
Power: 2W
Lift: Greater than 50,000 hours
Voltage: 110-200V 50/60Hz

Available finishing: Black / White / Grey

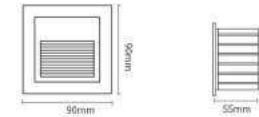

Model No. HO-UL-04-B

Material: Aluminum + Painting
Power: 2W
Lift: Greater than 50,000 hours
Voltage: 110-200V 50/60Hz

Available finishing: Black / White / Grey

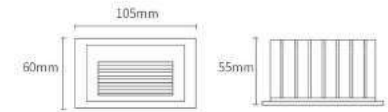

Model No. HO-UL-04-D

Material: Aluminum + Painting
Power: 2W
Lift: Greater than 50,000 hours
Voltage: 110-200V 50/60Hz

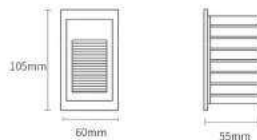

Model No. HO-UL-04-E

Material: Aluminum + Painting
Power: 2W
Lift: Greater than 50,000 hours
Voltage: 110-200V 50/60Hz

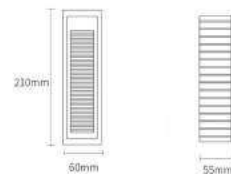

Model No. HO-UL-04-C

Material: Aluminum + Painting
Power: 4W
Lift: Greater than 50,000 hours
Voltage: 110-200V 50/60Hz

Available finishing: Black / White / Grey





Model No. HO-SPL-01

Material: Aluminum + Acrylic
 Power: 7W
 Lift: Greater than 50,000 hours
 Voltage: 110-220V 50/60Hz

Available finishing: Sand Black/ Sand Grey/Customized

Color Temperature:
 3000K Warm White, 2700K Warm White,
 5000K Neutral White, Amber*, Blue,
 Green, Red



Model No. HO-SPL-02

Material: Aluminum + Painting
 Power: COB* 7W
 Lift: Greater than 50,000 hours
 Voltage: 110-220V 50/60Hz

Available finishing: Sand Black/ Sand Grey

Color Temperature:
 3000K Warm White, 2700K Warm White,
 5000K Neutral White, Amber*, Blue,
 Green, Red



Model No. HO-PSPL-03

Material: Aluminum + Painting
 Power: COB* 7W
 Lift: Greater than 50,000 hours
 Voltage: 110-220V 50/60Hz

Available finishing: Sand Black/ Sand Grey

Color Temperature:
 3000K Warm White, 2700K Warm White,
 5000K Neutral White, Amber*, Blue,
 Green, Red





Model No. HO-SPL-04

Material: Aluminum + Acrylic
 Power: 5W
 Lift: Greater than 50,000 hours
 Voltage: 110-220V 50/60Hz

Available finishing: Sand Black/Customized

Color Temperature:
 3000K Warm White, 2700K Warm White,
 5000K Neutral White, Amber*, Blue,
 Green, Red



Model No. HO-SPL-06

Material: Aluminum + Painting
 Power: COB* 7W
 Lift: Greater than 50,000 hours
 Voltage: 110-220V 50/60Hz

Available finishing: Sand Black/ Sand Grey

Color Temperature:
 3000K Warm White, 2700K Warm White,
 5000K Neutral White, Amber*, Blue,
 Green, Red



Model No. HO-SPL-05

Material: Aluminum + Acrylic
 Power: 7W
 Lift: Greater than 50,000 hours
 Voltage: 110-220V 50/60Hz

Available finishing: Sand Black/ Sand Grey/Customized

Color Temperature:
 3000K Warm White, 2700K Warm White,
 5000K Neutral White, Amber*, Blue,
 Green, Red



Model No. HO-SPL-07

Material: Aluminum + Painting
 Power: COB* 6W / 12W / 18W
 Lift: Greater than 50,000 hours
 Voltage: 110-220V 50/60Hz

Available finishing: Sand Black/ Sand Grey

Color Temperature:
 3000K Warm White, 2700K Warm White,
 5000K Neutral White, Amber*, Blue,
 Green, Red

Model	Watt	Dia	H
HO-SPL-07-A	6W	φ105mm	150mm
HO-SPL-07-A	12W	φ140mm	180mm
HO-SPL-07-A	18W	φ160mm	180mm
HO-SPL-07-B	6W	φ105mm	120mm
HO-SPL-07-B	12W	φ140mm	160mm
HO-SPL-07-B	18W	φ160mm	180mm





LED Wall Washer Light

**Application for Urban construction project
commercial building, cultural square, building
external hall, overpass...**



Model No. HO-WL-011

Technical Parameters

Item No	HO-WL-011
Light Source	CREE /Bridgelux/ Osram/ Epistar
Power	36W
Power or each LED	1W/Pcs
LED Quantity	36Pcs
LED Color: (CCT)	Red/Green/Blue/Amber/White/ Warm White/RGB
Beam angle	15°30°45°60°15°45°
Housing Material	Aviation Aluminum, anodized surface painting
Lamp size	1000*50*35mm
Transparent Cover material	4mm Toughened ultra white glass
Working voltage	AC85-265V / DC24V
Control Mode	DMX512/Isolated constant current driver
Power factor	≥0.5 / ≥0.9
Power cable	3*0.75mm ² / 2*0.75mm ²
Environmental temperature	-20°C-50°C

Light-matching curve

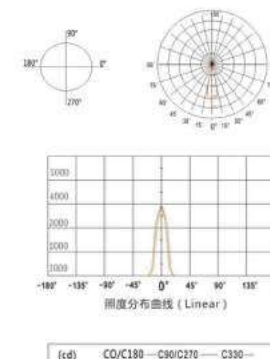



Model No. HO-WL-010

Technical Parameters

Item No	HO-WL-010
Light Source	CREE /Bridgelux/ Osram/ Epistar
Power	12W/18W/24W/36W/48W/60W
Power or each LED	1W/Pcs
LED Quantity	12Pcs/ 18Pcs/ 24Pcs/ 36Pcs / 48Pcs/ 60Pcs
LED Color (CCT)	Red/Green/Blue/Amber/White/ Warm White/RGB
Beam angle	15°30°45°60°15°45°
Housing Material	Aviation Aluminum, anodized surface painting
Lamp size	166*42*75mm(6W)
Transparent Cover material	4mm Toughened ultra white glass
Working voltage	DC24V
Control Mode	DMX512/Isolated constant current driver
Power factor	≥0.5 / ≥0.9
Power cable	3*0.75mm ² / 2*0.75mm ²
Environmental temperature	-20℃-50℃
IP Rate	IP65

Light-matching curve

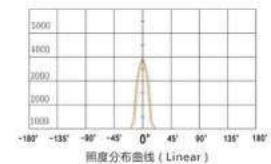
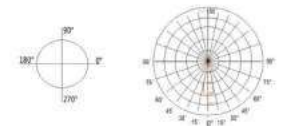

(cd) CO/C180—C90/C270—C330—



Model No. HO-WL-012

Tehcnical Parameters

Item No	HO-WL-012
Light Souce	CREE /Bridgelux/ Osram/ Epistar
Power	12W/18W/24W
Power or each LED	1W/Pcs
LED Quantity	12Pcs/ 18Pcs/ 36Pcs
LED Color (CCT)	Red/Green/Blue/Amber/White/ Warm White/RGB
Beam angle	15°30'45°60°15°45°
Housing Material	Aviation Aluminum,anodzed surface painting
Lamp size	1000*45*30mm
Transparent Cover material	4mm Toughened ultra white glass
Working voltage	AC85-265V / DC24V
Control Mode	DMX512/Isolated constant current driver
Power factor	≥0.5 / ≥0.9
Power cable	3*0.75mm ² / 2*0.75mm ²
Environmental temperature	-20℃-50℃
IP Rate	IP65

Light-matching curve

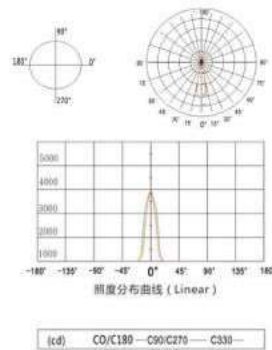

Model No. HO-WL-013

Tehcnical Parameters

Item No	HO-WL-013
Light Souce	CREE /Bridgelux/ Osram/ Epistar
Power	36W/ 48W
Power or each LED	1W/Pcs
LED Quantity	36Pcs / 48Pcs
LED Color (CCT)	Red/Green/Blue/Amber/White/ Warm White/RGB
Beam angle	15°30'45°60°15°45°
Housing Material	Aviation Aluminum,anodzed surface painting
Lamp size	1000*80*60mm
Transparent Cover material	4mm Toughened ultra white glass
Working voltage	AC85-265V / DC24V
Control Mode	DMX512/Isolated constant current driver
Power factor	≥0.5 / ≥0.9
Power cable	3*0.75mm ² / 2*0.75mm ²
Enviromental temperature	-20℃-50℃
IP Rate	IP65

Light-matching curve

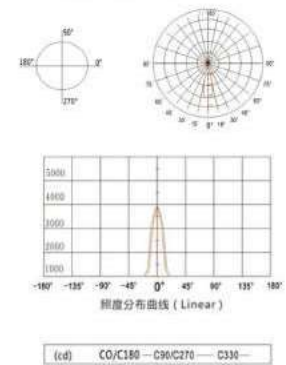



Model No : HO-DL-011

Model No.	Power	Cut-out	Product Size	Light Souce	Chip Brand	Chip Qty
HO-DL-011	3W	φ55mm	φ100*H65mm	Cree/Bridgelux	1W/PCs	3Pcs
HO-DL-011	5W	φ70mm	φ120*H75mm	Cree/Bridgelux	1W/PCs	5Pcs
HO-DL-011	9W	φ90mm	φ150*H90mm	Cree/Bridgelux	1W/PCs	9Pcs
HO-DL-011	12W	φ115mm	φ180*H90mm	Cree/Bridgelux	1W/PCs	12Pcs
HO-DL-011	18W	φ125mm	φ200*H75mm	Cree/Bridgelux	1W/PCs	18Pcs
HO-DL-011	24W	φ195mm	φ250*H80mm	Cree/Bridgelux	1W/PCs	24Pcs
HO-DL-011	36W	φ240mm	φ300*H90mm	Cree/Bridgelux	1W/PCs	36Pcs

Color Tem:

- 3000K Warm White
- 2700K Warm White
- 5000K Neutral White
- Amber* Blue,
- Green, Red
- RGB



Model No: HO-DL-010

Power: 1W
 Chip: Cree/ Bridgelux/ Epistar
 Size: 42*72*35mm
 52*72*46mm
 62*90*54mm

Color Temperature:
 3000K Warm White, 2700K Warm White,
 5000K Neutral White, Amber*, Blue,
 Green, Red





Model No: HO-DL-013

Item No	HO-DL-013-9	HO-DL-013-27	HO-DL-013-54	HO-DL-013-108
Lamp size	91*140mm	140*175mm	180*208mm	230*215mm
Power	9W	27W	54W	108W
LED Quantity	3Pcs	9Pcs	18Pcs	36Pcs
Power or each LED	3W/Pcs	3W/Pcs	3W/Pcs	3W/Pcs
LED Color (CCT)	Red/Green/Blue/Amber/White/ Warm White/RGB			
Beam angle	15°30'45°60°			
Housing Material	Aviation Aluminum,anodzed surface painting			
Light Souce	CREE /Bridgelux/ Osram/ Epistar			
Transparent Cover material	4mm Toughened ultra glass.			
Working voltage	AC175-265V/ DC24V			
Control Mode	Isolated driver			
Power factor	≥0.5 / ≥0.9			
Power cable	3*0.75mm ² / 2*0.75mm ²			
Enviromental temperature	-20°C-50°C			
IP Rate	IP65			



Model No : HO-DL-012

Tehcnical Parameters

Model No.	Power	Cut-out	Product Size	Light Souce	Chip Brand	Chip Qty
HO-DL-012	3W	φ65mm	φ100*H100mm	Cree/Bridgelux	1W/PCs	3Pcs
HO-DL-012	6W	φ85mm	φ150*H100mm	Cree/Bridgelux	1W/PCs	5Pcs
HO-DL-012	9W	φ112mm	φ180*H100mm	Cree/Bridgelux	1W/PCs	9Pcs
HO-DL-012	12W	φ112mm	φ180*H100mm	Cree/Bridgelux	1W/PCs	12Pcs
HO-DL-012	18W	φ142mm	φ200*H100mm	Cree/Bridgelux	1W/PCs	18Pcs
HO-DL-012	24W	φ160mm	φ250*H100mm	Cree/Bridgelux	1W/PCs	24Pcs
HO-DL-012	36W	φ190mm	φ250*H100mm	Cree/Bridgelux	1W/PCs	36Pcs
HO-DL-012	54W	φ190mm	φ300*H100mm	Cree/Bridgelux	1W/PCs	54Pcs

Color Tem:

- 3000K Warm White
- 2700K Warm White
- 5000K Neutral White
- Amber Blue, Green, Red
- RGB



Model No: HO-DL-014

Item No	HO-DL-014-18	HO-DL-014-32	HO-DL-014-48	HO-DL-014-60
Lamp size	96*96*150mm	135*135*215mm	170*170*260mm	213*213*345mm
Power	18W	32W	48W	120W
LED Quantity	9Pcs	16Pcs	24Pcs	60Pcs
Power or each LED	2W/Pcs	2W/Pcs	2W/Pcs	2W/Pcs
LED Color (CCT)	Red/Green/Blue/Amber/White/ Warm White/RGB			
Beam angle	15°30'45°60°			
Housing Material	Aviation Aluminum,anodzed surface painting			
Light Souce	CREE /Bridgelux/ Osram/ Epistar			
Transparent Cover material	4mm Toughened ultra glass			
Working voltage	AC175-265V/ DC24V			
Control Mode	Isolated driver			
Power factor	≥0.5 / ≥0.9			
Power cable	3*0.75mm ² / 2*0.75mm ²			
Enviromental temperature	-20°C-50°C			
IP Rate	IP65			



Model No: HO-DL-018-5
Power: 3W
Bridgelux/Osram/Epistar
0.2W/Pcs 12Pcs
Size: $\phi 85 \times 73$ mm
Beam Angle: 180°
CCT: 2500K/3000K/4000K/Red
Blue/ Green



Model No: HO-DL-019-3
Power: 3W
Bridgelux/Osram/Epistar
0.2W/Pcs 12Pcs
Size: $\phi 120 \times 70$ mm
Beam Angle: 180°
CCT: 2500K/3000K/4000K/Red
Blue/ Green



Model No: HO-DL-020-5
Power: 5W
Bridgelux/Osram/Epistar
1W/Pcs 5Pcs
Size: $\phi 140 \times 80$ mm
Beam Angle: 180°
CCT: 2500K/3000K/4000K/Red
Blue/ Green



Model No: HO-DL-021-7
Power: 7W
Bridgelux/Osram/Epistar
1W/Pcs 17Pcs
Size: $\phi 138 \times 85$ mm
Beam Angle: 180°
CCT: 2500K/3000K/4000K/Red
Blue/ Green



Model No: HO-DL-016-5
Power: 5W
Bridgelux/Osram/Epistar
0.2W/Pcs 18Pcs
Size: $\phi 100 \times 60$ mm
Beam Angle: 180°
CCT: 2500K/3000K/4000K/Red
Blue/ Green



Model No: HO-DL-017-3
Power: 3W
Bridgelux/Osram/Epistar
1W/Pcs 3Pcs
Size: $\phi 100 \times 90$ mm
Beam Angle: 180°
CCT: 2500K/3000K/4000K/Red
Blue/ Green



Model No: HO-DL-022-7
Power: 7W
Bridgelux/Osram/Epistar
1W/Pcs 7Pcs
Size: $\phi 165 \times 50$ mm
Beam Angle: 180°
CCT: 2500K/3000K/4000K/Red
Blue/ Green



Model No: HO-DL-23-3
Power: 3W
Bridgelux/Osram/Epistar
0.2W/Pcs 12Pcs
Size: $\phi 100 \times 83$ mm
Beam Angle: 180°
CCT: 2500K/3000K/4000K/Red
Blue/ Green



Model No: HO-DL-0127-6
 Power: 6W
 Bridgelux/Osram/Epistar
 1W/Pcs 6Pcs
 Size: 210*46*10mm
 Beam Angle: 15°30°45°60°
 CCT: 3000K/4000K/6000K
 Red/Blue/Green



Model No: HO-DL-0128-9
 Power: 9W
 Bridgelux/Osram/Epistar
 1W/Pcs 9Pcs
 Size: 205*56*95mm
 Beam Angle: 15°30°45°60°
 CCT: 3000K/4000K/6000K
 Red/Blue/Green



Model No: HO-DL-0129-6
 Power: 6W
 Bridgelux/Osram/Epistar
 1W/Pcs 6Pcs
 Size: 160*50*60mm
 Beam Angle: 15°30°45°60°
 CCT: 3000K/4000K/6000K
 Red/Blue/Green



Model No: HO-DL-0130-6
 Power: 6W
 Bridgelux/Osram/Epistar
 1W/Pcs 6Pcs
 Size: 181*42*23mm
 Beam Angle: 15°30°45°60°
 CCT: 3000K/4000K/6000K
 Red/Blue/Green



Model No: HO-DL-0124-3
 Power: 3W
 Bridgelux/Osram/Epistar
 3W/Pcs 1Pcs
 Size: 120*120*40mm
 Beam Angle: 15°30°45°60°
 CCT: 3000K/4000K/6000K
 Red/Blue/Green



Model No: HO-DL-0125-2
 Power: 2W
 Bridgelux/Osram/Epistar
 1W/Pcs 2Pcs
 Size: 120*120*40mm
 Beam Angle: 15°30°45°60°
 CCT: 3000K/4000K/6000K
 Red/Blue/Green



Model No: HO-DL-0126-3
 Power: 3W
 Bridgelux/Osram/Epistar
 1W/Pcs 3Pcs
 Size: 120*120*40mm
 Beam Angle: 15°30°45°60°
 CCT: 3000K/4000K/6000K
 Red/Blue/Green



Model No: HO-DL-0131-5
 Power: 5W
 Bridgelux/Osram/Epistar
 1W/Pcs 5Pcs
 Size: 190*30*92mm
 Beam Angle: 15°30°45°60°
 CCT: 3000K/4000K/6000K
 Red/Blue/Green



Model No: HO-DL-0132-6
 Power: 6W
 Bridgelux/Osram/Epistar
 1W/Pcs 6Pcs
 Size: 196*37*50mm
 Beam Angle: 15°30°45°60°
 CCT: 3000K/4000K/6000K
 Red/Blue/Green